



HP 4339A
High Resistance Meter
Operation Manual

WARNING

HIGH VOLTAGE SHOCK HAZARD (MAX. 1000 Vdc)

The HP 4339A High Resistance Meter forces dangerous voltage up to 1000 Vdc on the UNKNOWN terminals, or the electrodes of the accessory (the HP 16008B Resistivity Cell, the HP 16339A Test Fixture, or the HP 16117B,C Test Leads) which is connected to the HP 4339A. (When the High Voltage indicator on the front panel is ON, the HP 4339A outputs dangerous voltage more than 42 Vdc.) To prevent an electrical shock, observe the following safety precautions.

- Operate the HP 4339A and the accessories following the description on their *Operation (and Service) Manuals*, especially for the description written in the Warnings.
- Do *not* touch the UNKNOWN terminal or the electrode, when the V Output indicator on the front panel is ON, that is, when the HP 4339A forces voltage.
- Perform the operation tests of the interlock function and the High Voltage indicator at least once a day, before using the HP 4339A. Refer to "Checking Procedure" in chapter 3 of the *Operation and Service Manual* of the each accessory for the operation tests procedures.
- Warn workers around the HP 4339A about dangerous conditions.

警告

高電圧感電注意 (最大 1000 Vdc)

HP 4339A ハイ・レジスタンス・メータは、UNKNOWN端子、または、HP 4339Aに接続されたアクセサリ (HP 16008Bレジスティビティ・セル、HP 16339Aテスト・フィクスチャ、または、HP 16117B,Cテスト・リード) の電極に危険電圧 (最大 1000 Vdc) を出力することがあります。この危険電圧による感電を避けるために、下記の事項を必ず実施してください。

- ・ HP 4339Aを操作するときには、必ずマニュアルの記述に従ってください。特に、「警告」に書かれていることは必ず守ってください。
- ・ 電圧出力中 (フロント・パネルのV Outputインディケータの点灯中) は、UNKNOWN端子、または、アクセサリの電極に触れないでください。
- ・ 測定に使用するアクセサリを使って、測定開始前に、Interlock機能、High Voltageインディケータの動作テストを行ってください。(1日1回以上) 手順は、各アクセサリのOperating and Service Manualの3章の"Checking Procedure"項を参照してください。
- ・ 周囲の他の作業者に対しても、危険電圧を出力することがあることを知らせ、UNKNOWN端子、または、アクセサリの電極に触れないように注意してください。

AVVERTENZA

PERICOLO DI SCOSSA AD ALTA TENSIONE (MAX. 1000 Vdc)

L'ohmmetro HP 4339A emette pericolosi livelli di tensione che possono raggiungere i 1000 Vdc sui terminali UNKNOWN, o sugli elettrodi degli impianti di prova o cavi di prova (Cella di resistività HP 16008B, Impianto di prova HP 16339A, o Cavi di prova C HP 16117B) che sono collegati all'HP 4339A. (Quando l'indicatore High Voltage sul pannello anteriore è attivato (ON), l'HP 4339A emette tensione elettrica pericolosa (più di 42 Vdc)) Per prevenire una scossa elettrica, osservare le seguenti precauzioni di sicurezza.

- Usare l'HP 4339A e gli accessori secondo le istruzioni dei rispettivi Manuali d'istruzione (e Servizio), specialmente le istruzioni date nelle "Avvertenze".
- Non toccare i terminali UNKNOWN o gli elettrodi quando l'indicatore V Output o il pannello anteriore sono attivati (ON): cioè quando della tensione viene applicata all'uscita dell'HP 4339A.
- Eseguire le prove di funzionamento della funzione Interlock e dell'indicatore High Voltage almeno una volta al giorno, prima di usare l'HP 4339A. Fare riferimento al "Checking Procedure" al capitolo 3 dell'Operation and Service Manual dell'accessorio che si sta usando per le procedure della prova di funzionamento.
- Informare gli operatori che si occupano dell'HP 4339A, delle condizioni di pericolo esistenti e riferire loro ciò che è possibile fare e ciò che non lo è!

WARNUNG

LEBENSGEFÄHRLICHE HOCHSPANNUNG (MAX. 1000 Vdc)

Das Hochwiderstandsmeßgerät HP 4339A gibt eine gefährliche Hochspannung von bis zu 1000 Vdc an den UNKNOWN-Klemmen oder an den Elektroden von Zubehör (z.B. Widerstandszelle HP 16008B, Meßvorrichtungen HP 16339A oder Meßleitungen HP 16117B,C), welche an den HP 4339A angeschlossen sind, ab. (Wenn der Hochspannungsindikator auf der Vorderseite an ist, gibt der HP 4339A eine Spannung von mehr als 42 Vdc ab.) Um elektrische Schläge zu vermeiden, sind folgende Sicherheitsmaßnahmen zu beachten:

- Bedienen Sie den HP 4339A und seine Zubehörteile immer nur unter Einhaltung der Anweisungen in den zugehörigen Bedienungsanleitungen, insbesondere unter Beachtung der darin enthaltenen Warnungen.
- Berühren Sie nicht die UNKNOWN-Klemmen der Elektrode, wenn der V-Output-Indikator an der Vorderseite aufleuchtet, d.h., wenn der HP 4339A eine Spannung ausgibt.
- Führen Sie den Funktionstest der Interlock-Funktion und des Hochspannungsindikators wenigstens ein Mal täglich aus, bevor Sie den HP 4339A für Messungen benutzen. Beziehen Sie sich hierzu auf den Abschnitt "Checking Procedure" in Kapitel 3 im *Operation and Service Manual* des jeweiligen Zubehörs.
- Informieren Sie Kollegen/Kolleginnen in der Nähe des HP 4339A über gefährliche Betriebszustände.

AVISO

PELIGRO DE DESCARGA ELECTRICA DE ALTA TENSION (MAX. 1000 V. CC)

El Medidor de Alta Resistencia modelo HP 4339A genera tensiones peligrosas de hasta 1000 V. cc en los terminales UNKNOWN, así como en los electrodos de los accesorios del equipo (la Célula de Resistividad HP 16008B, el Accesorio de Medida HP 16339A, o las Sondas de Prueba HP 16117B,C) conectados al HP 4339A. (Cuando el indicador de "High Voltage" -alta tensión- del panel frontal esté encendido, entonces el HP 4339A producirá unas tensiones peligrosas en sus conectores de salida, con valores superiores a los 42 V. cc). Para evitar las posibles descargas eléctricas, hay que respetar las siguientes medidas de seguridad:

- Manejar el HP 4339A y sus accesorios siguiendo las instrucciones que se indican en los manuales de operación y mantenimiento (*Operation and Service Manuals*), prestando especial atención a las descripciones indicadas en los Avisos correspondientes.
 - No tocar ninguno de los terminales UNKNOWN ni los electrodos, cuando el indicador "V Output" del panel frontal esté encendido, es decir, cuando el HP 4339A esté suministrando tensión en sus bornes.
 - Antes de utilizar el HP 4339A realice las pruebas de funcionamiento de la función "interlock" y del indicador "High Voltage", al menos una vez al día. Puede consultar la sección "Checking Procedure" (Procedimientos de Comprobación) del capítulo 3 del manual *Operation and Service Manual* suministrado con cada uno de los accesorios, para conocer los procedimientos de pruebas operacionales.
 - Advierta a las personas que trabajen alrededor del HP 4339A, sobre las posibles situaciones de peligro que pueden producirse.
-

AVERTISSEMENT

RISQUES D'ELECTROCUTION — HAUTE TENSION (1000 VOLTS)

Le mesureur haute résistance HP 4339A produit des tensions élevées pouvant atteindre 1000 volts (courant continu) entre les bornes UNKNOWN de l'instrument ou les électrodes de l'accessoire support de test raccordé (cellule de résistivité HP 16008B, support de test de composant HP 16339A, cordons de test HP 16117B/C). Lorsque le voyant High Voltage de la face avant est allumé, la tension de sortie est supérieure à 42 volts. Pour éviter tout risque d'électrocution, observez les précautions suivantes :

- N'utilisez le HP 4339A et ses accessoires que de la façon décrite dans leurs manuels respectifs (*Operation Manual et Service Manual*), en respectant en particulier les notes d'avertissement.
- Ne touchez JAMAIS aux bornes UNKNOWN de l'instrument ni aux électrodes lorsque le voyant "V Output" de la face avant est allumé, c'est-à-dire quand la sortie du HP 4339A est sous tension.
- Exécutez les tests de fonctionnement de la fonction de sécurité (Interlock) et du voyant "High Voltage" au moins une fois par jour avant de commencer à vous servir du HP 4339A. Reportez-vous à la section "Checking Procedure" du chapitre 3 du *HP 4339A Operation and Service Manual* de chaque accessoire pour connaître les procédures de test.
- Informez les opérateurs travaillant autour du HP 4339A des risques liés à son utilisation.

警告

高压危险(最高电压: 1000Vdc(直流))

在HP4339A高电阻表的UNKNOWN端以及测量固定件或测量导线的电极处(HP16008B阻抗电池、HP16339A测量固定件、HP16117B、C测量导线),会有1000Vdc(直流)的危险电压。而这些端头都是与HP4339A相连接的。(当前面板上的High Voltage指示器处于ON(接通)的位置时,HP4339A有高于42Vdc(直流)的危险电压输出)为了防止触电,请遵守下列安全注意事项。

- 在操作HP4339A及其附件时,请按照操作说明书(或维修说明书)中的指示进行操作,并特别注意“警告”中的注意事项。
- 当前面板上的V Output指示器处于ON(接通)状态时,请不要触摸UNKNOWN端及电极,因为这时HP4339A有输出电压。
- 在使用HP4339A之前,请参照您在操作测量过程中使用的附件的 Operation and Service Manual的第3章的“Checking Procedure”的内容,每日最少进行一次操作测量的Interlock功能和High Voltage指示器的操作。
- 请警告HP4339A周围的作业人员高压危险的存在,并使他们的知道该做什么和不该做什么!

警告

高壓危險(最高電壓: 1000Vdc(直流))

在HP4339A高電阻錶的UNKNOWN端以及測量固定零件或測量導線的電極處(HP16008B阻抗電池、HP16339A測量固定零件、HP16117B、C測量導線),會有1000Vdc(直流)的危險電壓。而這些端交都是與HP4339A相連接的。(當前面板上的High Voltage指示器處於ON(接通)的位置時,HP4339A有高於42Vdc(直流)的危險電壓輸出。)為了防止觸電,請遵守下列安全注意事項。

- 在操作HP4339A及其附件時,請按照操作說明書(或維修說明書)中的指示進行操作,並特別要注意“警告”中的注意事項。
- 當前面板上的V Output指示器處於ON(接通)狀態時,請不要觸摸UNKNOWN端及電極,因為這時HP4339A有輸出電壓。
- 在使用HP4339A之前,請參照您在操作測量過程中使用的附件的 Operation and Service Manual的第3章的“Checking Procedure”的內容,每日最少進行一次操作測量的Interlock功能和High Voltage指示器的操作。
- 請警告HP4339A周圍的作業人員高壓危險的存在,並使他們知道該做什麼和不該做什麼。

경고

고전압 쇼크 위험(최대 1000V 직류)

UNKNOWN 단자, 또는 HP 4339A에 연결되어 있는 테스트 설비의 전극봉 혹은 테스트 리드선(16008 B 저항 셀, HP 16339A 테스트 설비, 또는 HP 16117B, C 테스트 리드선)에는 직류 1000V 정도의 위험한 전압 레벨의 HP 4339A 고저항계 출력(프론트 패널에 High Voltage 지시계가 ON일 때, 직류 42V 이상의 HP 4339A 출력으로 위험한 전압입니다.)으로서, 전기적 쇼크를 방지하기 위하여 다음의 안전 유의사항을 주의깊게 참조해 주십시오.

- HP 4339A 및 부속품의 자동(혹은 서비스) 취급 설명서에 따른 지시대로 작동해 주십시오.
- UNKNOWN 단자 혹은 전극봉은 접촉을 절대로 삼가해야 하며, V Output 지시계의 프론트 패널이 ON일 때, 전압은 HP 4339A의 출력전압입니다.
- HP 4339A는 사용전에, Interlock 기능의 작동시험과 High Voltage 지시계를 적어도 1일에 1회 점검해야 합니다. 작동 테스트 진행순서를 위한 부속품의 Operation and Service Manual의 3장에 있는 "Checking Procedure" 를 참조해 주십시오.
- HP 4339A의 주위는 매우 위험하므로, 작업자는 안전사항을 반드시 준수해야 합니다.

Vertical text on the right edge of the page, possibly bleed-through or a margin note. The text is extremely faint and difficult to decipher, but appears to contain several lines of characters.

DECLARATION OF CONFORMITY

according to ISO/IEC Guide 22 and EN 45014

Manufacturer's Name: Yokogawa-Hewlett-Packard, LTD.

Manufacturer's Address: 9-1, Takakura-cho, Hachioji-shi, Tokyo, 192 Japan

declares, that the product

Product Name : High Resistance Meter

Model Number(s) : HP 4339A

Product Options : This declaration covers all options of the above product.

conforms to the following Product Specifications :

Safety : HD-401 (equivalent to IEC 348, 1978)

EMC : EN55011 (1991) Group 1, Class A
prEN50082-1 (1991)

Supplementary Information :

Tokyo, Japan
Location

January 1, 1992
Date

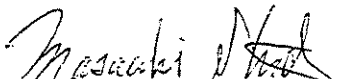
Masaaki Shida / QA Manager

Herstellerbescheinigung

Hiermit wird bescheinigt, daß das Gerät HP 4339A High Resistance Meter in Übereinstimmung mit den Bestimmungen von Postverfügung 1046/84 funkentstört ist.

Der Deutschen Bundespost wurde das Inverkehrbringen dieses Gerätes angezeigt und die Berechtigung zur Überprüfung der Serie auf Einhaltung der Bestimmungen eingeräumt.

Anm: Werden Meß- und Testgeräte mit ungeschirmten Kabeln und/oder in offenen Meßaufbauten verwendet, so ist vom Betreiber sicherzustellen, daß die Funk-Entstörbestimmungen unter Betriebsbedingungen an seiner Grundstücksgrenze eingehalten werden.

GERÄUSCHEMISSION

LpA < 70 dB
am Arbeitsplatz
normaler Betrieb
nach DIN 45635 T. 19

Manufacturer's Declaration

This is to certify that this product, the HP 4339A High Resistance Meter, meets the radio frequency interference requirements of directive 1046/84. The German Bundespost has been notified that this equipment was put into circulation and was granted the right to check the product type for compliance with these requirements.

Note: If test and measurement equipment is operated with unshielded cables and/or used for measurements on open set-ups, the user must insure that under these operating conditions, the radio frequency interference limits are met at the border of his premises.

ACOUSTIC NOISE EMISSION

LpA < 70 dB
operator position
normal operation
per ISO 7779

1870
1871
1872
1873
1874
1875
1876
1877
1878
1879
1880
1881
1882
1883
1884
1885
1886
1887
1888
1889
1890
1891
1892
1893
1894
1895
1896
1897
1898
1899
1900

HP 4339A High Resistance Meter Operation Manual

SERIAL NUMBERS

This manual applies directly to instruments with serial number prefix 3148J. For additional important information about serial numbers, read "Serial Number" in Appendix A.



HP Part No. 04339-90000
Microfiche Part No. 04339-90050
Printed in Japan July 1994

3rd Edition

Warranty

This Hewlett-Packard instrument product is warranted against defects in material and workmanship for a period of one year from the date of shipment. During the warranty period, Hewlett-Packard Company will, at its option, either repair or replace products which prove to be defective.

For warranty service or repair, this product must be returned to a service facility designated by HP. The Buyer shall prepay shipping charges to HP and HP shall pay shipping charges to return the product to the Buyer. However, the Buyer shall pay all shipping charges, duties, and taxes for products returned to HP from another country.

HP warrants that its software and firmware designed by HP for use with an instrument will execute its programming instruction when properly installed on that instrument. HP does not warrant that the operation of the instrument, or software, or firmware will be uninterrupted or error free.

Limitation of Warranty

The foregoing warranty shall not apply to defects resulting from improper or inadequate maintenance by the Buyer, Buyer-supplied software or interfacing, unauthorized modification or misuse, operation outside of the environmental specifications for the product, or improper site preparation or maintenance.

No other warranty is expressed or implied. HP specifically disclaims the implied warranties of merchantability and fitness for a particular purpose.

Certification

Hewlett-Packard Company certifies that this product met its published specifications at the time of shipment from the factory. Hewlett-Packard further certifies that its calibration measurements are traceable to the United States National Institute of Standards and Technology, to the extent allowed by the Institute's calibration facility, or to the calibration facilities of other International Standards Organization members.

Exclusive Remedies

The remedies provided herein are the buyer's sole and exclusive remedies. HP shall not be liable for any direct, indirect, special, incidental, or consequential damages, whether based on contract, tort, or any other legal theory.

Assistance

Product maintenance agreements and other customer assistance agreements are available for Hewlett-Packard products.

For any assistance, contact your nearest Hewlett-Packard Sales and Service Office. Addresses are provided at the back of this manual.

Notice

The information contained in this document is subject to change without notice.

This document contains proprietary information which is protected by copyright. All rights are reserved. No part of this document may be photocopied, reproduced, or translated to another language without the prior written consent of the Hewlett-Packard Company.

Yokogawa-Hewlett-Packard, LTD.
Kobe Instrument Division
1-3-2, Murotani, Nishi-Ku, Kobe-Shi
Hyogo 651-22 Japan

Manual Printing History

The manual printing date and part number indicate its current edition. The printing date changes when a new edition is printed. (Minor corrections and updates which are incorporated at reprint do not cause the date to change.) The manual part number changes when extensive technical changes are incorporated.

November 1991 First Edition
December 1992 Second Edition
July 1994 Third Edition

Safety Summary

The following general safety precautions must be observed during all phases of operation, service, and repair of this instrument. Failure to comply with these precautions or with specific **WARNINGS** given elsewhere in this manual violates safety standards of design, manufacture, and intended use of the instrument.

The Hewlett-Packard Company assumes no liability for the customer's failure to comply with these requirements.

Ground the Instrument

This is a Safety Class I product (provided with a protective earth (ground) terminal). An uninterruptible safety earth ground must be provided from the main power source to the product input wiring terminals, power cord, or supplied power cord set. Whenever it is likely that the protection has been impaired, the product must be made inoperative and secured against any unintended operation.

Do NOT Operate in an Explosive Atmosphere

Do *not* operate the instrument in the presence of flammable gasses or fumes. Operation of any electrical instrument in such an environment constitutes a safety hazard.

Keep Away from Live Circuits

Operating personnel must not remove instrument covers. Component replacement and internal adjustments must be made by qualified maintenance personnel. Do not replace components with the power cable connected. Under certain conditions, dangerous voltages may exist even with the power cable removed. To avoid injuries, always disconnect power and discharge circuits before touching them.

Do NOT Service or Adjust Alone

Do *not* attempt internal service or adjustment unless another person, capable of rendering first aid and resuscitation, is present.

Do NOT Substitute Parts or Modify Instrument

Because of the danger of introducing additional hazards, do *not* substitute parts or perform unauthorized modifications to the instrument. Return the instrument to a Hewlett-Packard Sales and Service Office for service and repair to ensure that safety features are maintained.

Dangerous Procedure Warnings

Warnings, such as the example below, precede potentially dangerous procedures throughout this manual. Instructions contained in the warnings must be followed.

Warning



Dangerous voltages, capable of causing death, are present in this instrument. Use extreme caution when handling, testing, and adjusting this instrument.

In This Manual

- **Chapter 1, Getting Started**

Provides an overview of the product and basic measurement procedures. Begin with this chapter, if you are a first time user.
- **Chapter 2, Operating the HP 4339A**

Provides step-by-step instructions for operating the front panel keys of the HP 4339A. Read this chapter, when you want to know how to perform tasks using the front panel keys.
- **Chapter 3, Function Reference**

Provides information on all the instrument's functions. Read this chapter, when you want to know the functions of the keys and the terminals on the front and rear panels.
- **Chapter 4, Remote Operation**

Provides step-by-step instructions for HP-IB remote control of the HP 4339A through HP-IB. Read this chapter, when you want to know how to perform tasks using HP-IB remote mode.
- **Chapter 5, HP-IB Reference**

Provides information for HP-IB remote control of the HP 4339A. Read this chapter, when you want to know the description of the each HP-IB command, the status reporting structure, the trigger system, and the data transfer formats.
- **Chapter 6, Application Measurement**

Provides application measurement examples using the HP 4339A.
- **Chapter 7, Measurement Basics**

Provides information that will help you work more effectively.
- **Chapter 8, General Information**

Provides specifications, and supplemental characteristics.
- **Chapter 9, Maintenance**

Provides the information on how to verify conformance to published specifications.
- **Appendix A, Manual Changes**



Provides information for adapting this manual to use with HP 4339A manufactured before the printing date of the manual.
- **Appendix B, Handler Interface Installation**



























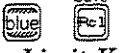









Provides the information necessary to install the handler interface. Before you use the handler, read this appendix and configure the handler's input and output signals.
- **Messages**

Provides information on the messages that are displayed on the HP 4339A's LCD display or transmitted by the instrument over HP-IB in numeric order.

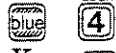
Contents

1. Getting Started	
Introduction	1-1
Overview	1-2
Features	1-2
Accessories Available	1-3
Options Available	1-3
Front Panel	1-4
Display	1-6
Rear Panel	1-7
Initial Inspection	1-8
Preparation for Use	1-9
Power Requirements	1-9
Turning ON the HP 4339A	1-9
Power-On Self Test	1-10
Using Front Panel Keys	1-11
Direct Execution Type Keys	1-11
Toggle Type Keys	1-11
Selection Type Keys	1-11
Value Setup Type Keys	1-12
Value Setup Using Numeric Keys	1-12
Value Setup Using Maximum and Minimum Keys	1-13
Value Setup Using Down and Up Arrow Keys	1-13
Value Change Using Back Space Key	1-13
Basic Operation	1-15
Connecting Test Fixture	1-16
Floating DUT Measurement	1-16
Grounded DUT Measurement	1-16
Resetting HP 4339A	1-17
Performing Calibration	1-17
Performing OPEN Correction	1-18
Selecting Measurement Parameter	1-19
Setting Test Voltage	1-20
Selecting Measurement Range	1-20
Auto Range mode	1-20
Hold Range mode	1-20
Changing the Range in Hold Range mode	1-20
Applying Test Voltage	1-21
Turning OFF Test Voltage	1-21

2. Operating the HP 4339A	
Introduction	2-1
Measurement Configuration	2-2
Selecting the Measurement Time Mode	2-2
Setting the Averaging Rate	2-2
Setting the Trigger Delay Time	2-2
Setting the Parameters for Resistivity Measurement	2-3
Entering Thickness of the DUT	2-3
Setting the Electrode Size	2-4
Making a Measurement	2-6
Triggering a Measurement	2-6
Using the Comparator Function	2-6
Displaying Deviation Data	2-8
Setting the Reference Value	2-8
Selecting the Deviation Display Mode	2-9
Using the Measurement Sequence Function	2-10
Selecting the Measurement Sequence Mode	2-10
Setting the Measurement Sequence Mode Parameters	2-10
Starting Measurement Sequence	2-11
Aborting Measurement Sequence	2-11
Setting Contact Check	2-12
Setting the Current Limit	2-12
Setting Beeper Mode	2-12
Saving and Recalling Instrument Settings	2-13
Locking Out the Front Panel Keys	2-14
Selecting Local Mode	2-14
Setting the HP-IB Address	2-14
Printing Measurement Data	2-14
Setting the Offset-Error Canceling Function	2-15
Using the HP 4339A with an Auto-Handler	2-16
Testing the HP 4339A	2-17
Performing a Self-Test	2-17
Testing the Front Panel Key's Functionality	2-18
If You Have a Problem	2-19
If the Display is Blank and the HP 4339A Appears Dead	2-19
If an Error Message is Displayed	2-19
If the HP 4339A does not Accept Any Key Input	2-19
If the Display Displays Annunciators Only	2-19
If the Indicated Value is not Stable	2-19
If You Find Yourself Lost When Operating the HP 4339A	2-19
3. Function Reference	
Introduction	3-1
Front Panel	3-2
Display	3-2
LINE Switch	3-3
Interlock Connector	3-3
UNKNOWN Terminals	3-4
High Voltage Indicator	3-4
V Output Key 	3-4
V Output Indicator	3-5
Source Voltage key 	3-5
Current Limit Key 	3-5

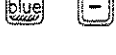
Measurement Time key		3-5
Average key		3-5
Measurement Sequence Mode Key		3-6
Single Mode		3-6
Continuous mode		3-6
Program Key		3-7
Measurement Parameter Key		3-8
Electrode Size Key		3-8
Deviation Mode Key		3-9
Deviation (Δ) Reference Key		3-10
Auto/Hold Range Key		3-10
Range Setup Key		3-10
Trigger Key		3-10
Sequence Abort Key		3-10
Local Key		3-11
Address Key		3-11
Trigger Mode Key		3-11
Delay Key		3-11
Recall Key		3-11
Save Key		3-12
Comparator Limit Key		3-12
Comparator On/Off Key		3-12
Down and Up Arrow Keys		3-13
0, . . . , 9, .(point), -(minus) Keys	   	3-13
Shift Key		3-13
Exponential Key		3-13
Back Space Key		3-13
Enter Key		3-13
Minimum Key		3-13
Maximum Key		3-13
Open Key		3-14
Calibration Key		3-14
Contact Check Key		3-14
Display Mode Key		3-15
Key Lock Key		3-15
Reset Key		3-16
Configuration Key		3-17

Rear Panel	3-20
External Trigger	3-20
Handler Interface	3-21
Specifications	3-21
Electrical Characteristics	3-24
Output Signals	3-24
Input Signals	3-27
HP-IB Interface	3-28
LINE Fuse Holder	3-29
LINE Voltage Selector	3-29
Power Cord Receptacle	3-29
Power Cord	3-29
Serial Number Plate	3-31
Theory of Operation	3-32
Overall Measurement Theory	3-32
Overall Block Diagram	3-33
Grounded and Ungrounded DUT Measurement Configuration	3-34

4. Remote Operation

Introduction	4-1
Getting Started	4-2
Input/Output Statements	4-2
Reading the HP-IB Address	4-2
Sending a Remote Command	4-2
Returning to Local Mode	4-3
Query Commands	4-3
Getting Data from the HP 4339A	4-3
To Control the HP 4339A from an External Computer	4-4
To Set Up the HP 4339A	4-5
To Reset the HP 4339A	4-5
To Set the Power LINE Frequency	4-5
To Select the Measurement Parameter	4-5
To Set the Test Voltage	4-5
To Apply the Test Voltage	4-6
To Set the Current Limit	4-6
To Select Measurement Time Mode	4-6
To Perform Calibration	4-6
To Perform OPEN Correction	4-7
To Select the Measurement Range	4-7
To Set the Averaging Rate	4-7
To Set Trigger Delay Time	4-7
To Set the Parameters for Resistivity Measurements	4-8
To Set Beeper Mode	4-8
To Lock Out the Front Panel Keys	4-8
To Check Contact Integrity at the Test Fixture	4-8
To Use the Comparator Function	4-9
To Display a Deviation Measurement	4-9
To Set the Offset-Error Canceling Function	4-9
To Wait Until Previously Sent Commands are Completed	4-9
To Get the Current Instrument Settings	4-10
To Save and Recall Instrument Settings	4-10
To Trigger a Measurement	4-11
To set the Internal trigger mode:	4-11
To set to the Manual trigger mode:	4-11
To set to the External trigger mode:	4-12

- To set to the Bus trigger mode: 4-12
 - Using the *TRG Command, 4-12
 - Using the Group Execution Trigger (GET): 4-12
- To trigger a measurement regardless of the trigger source: 4-13
 - Data Retrieval 4-13
- To Retrieve Data Efficiently 4-14
 - To Transfer Data Using Real data Format 4-14
 - To Use Data Buffer 4-14
 - To Perform a Measurement Sequence 4-15
- Other Features 4-16
 - To Test the HP 4339A 4-16
 - To Read the Error Queue 4-16
 - To Report the Instrument's Status 4-16
- Sample Program 4-18
- If You Have a Problem 4-20
 - If the HP 4339A Hangs Up When You Send the ABORt Command 4-20

5. HP-IB Reference

- Introduction 5-1
- HP-IB Commands 5-1
 - Common Commands 5-1
 - Subsystem Commands 5-1
 - Subsystem Command Tree 5-1
 - Program Message Syntax 5-2
 - Command Abbreviations 5-2
 - Case 5-3
 - Program Message Terminator 5-3
 - Common Command Syntax 5-3
 - Subsystem Command Syntax 5-3
 - Parameters 5-3
 - Parameter Types 5-3
 - Multiple Messages 5-4
 - Query and Response Message Syntax 5-4
- Command Reference 5-6
 - Notations 5-6
- ABORt Command 5-7
 - :ABORt 5-7
- ARM Subsystem 5-8
 - :ARM[:SEquence1][:LAYer]:DELay <numeric_value> [MS|S] 5-8
 - :ARM[:SEquence1][:LAYer]:SOURce {BUS|EXtErnal|MANual|IMMediate} 5-8
- CALCulate Subsystem 5-9
 - :CALCulate:FORMat { REAL | SRESistivity | VRESistivity } 5-10
 - :CALCulate:LIMit:BEEPer:CONDition { PASS | FAIL } 5-10
 - :CALCulate:LIMit:BEEPer[:STATe] { ON | OFF | 1 | 0 } 5-10
 - :CALCulate:LIMit:CLEar 5-10
 - :CALCulate:LIMit:FAIL? 5-11
 - :CALCulate:LIMit:LOWer[:DATA] <numeric_value> 5-11
 - :CALCulate:LIMit:LOWer:STATe { ON | OFF | 1 | 0 } 5-11
 - :CALCulate:LIMit:STATe { ON | OFF | 1 | 0 } 5-11
 - :CALCulate:LIMit:UPPer[:DATA] <numeric_value> 5-11
 - :CALCulate:LIMit:UPPer:STATe { ON | OFF | 1 | 0 } 5-11
 - :CALCulate:MATH:EXPRession:CATalog? 5-12
 - :CALCulate:MATH:EXPRession:NAME { DEV | PCNT } 5-12
 - :CALCulate:MATH:STATe { ON | OFF | 1 | 0 } 5-12
 - :CALCulate:PATH? 5-12

:CALCulate:RESistivity:EAREa <numeric_value>	5-12
:CALCulate:RESistivity:EPERimeter <numeric_value>	5-12
:CALCulate:RESistivity:GLENgtH <numeric_value>	5-13
:CALCulate:RESistivity:STHickness <numeric_value>	5-13
CALibration Subsystem	5-14
:CALibration[:ALL]?	5-14
:CALibration:AUTO { ON OFF }	5-14
DATA Subsystem	5-15
DATA[:DATA] REF <numeric_value>	5-15
DATA[:DATA]? DBUF	5-15
:DATA:FEED DBUF <data_handle>	5-16
:DATA:FEED:CONTRol DBUF { ALWAYS NEVER }	5-16
:DATA:POINts DBUF <numeric_value>	5-16
DISPlay Subsystem	5-17
:DISPlay[:WINDow][:STATe] { ON OFF 1 0 }	5-17
:DISPlay[:WINDow]:TEXT:PAGE { 1 2 3 }	5-17
FETCh? Query	5-18
:FETCh?	5-18
FORMat Subsystem	5-19
:FORMat[:DATA] { ASCii REAL[,64] }	5-19
INITiate Subsystem	5-20
:INITiate[:IMMediate]	5-20
:INITiate:CONtinuous { ON OFF 1 0 }	5-20
OUTPut Subsystem	5-21
:OUTPut[:STATe] { ON OFF 1 0 }	5-21
SENSe Subsystem	5-22
[:SENSe]:AVERage:COUNT <numeric_value>	5-22
[:SENSe]:AVERage[:STATe] { ON OFF 1 0 }	5-22
[:SENSe]:CORRection:COLLect[:ACQuire] OFFset	5-22
[:SENSe]:CORRection[:STATe] { ON OFF 1 0 }	5-22
[:SENSe]:CURRent:APERture <numeric_value>[MS S]	5-23
[:SENSe]:CURRent:RANGe:AUTO { ON OFF 1 0 }	5-23
[:SENSe]:CURRent:RANGe[:UPPer] <numeric_value>[PA NA UA A]	5-23
[:SENSe]:FUNctioN <sensor_function>	5-23
[:SENSe]:RESistance:CONtact:VERify { ON OFF 1 0 }	5-23
SOURce Subsystem	5-24
:SOURce:CURRent:LIMit[:AMPLitude] <numeric_value> [MA A]	5-24
:SOURce:VOLtagE[:LEVel][:IMMediate][:AMPLitude] <numeric_value> [KV V]	5-24
STATus Subsystem	5-25
:STATus:OPERation:CONDition?	5-25
:STATus:OPERation:ENABle <numeric_value>	5-25
:STATus:OPERation[:EVENT]?	5-25
:STATus:PRESet	5-25
:STATus:QUEStionable:CONDition?	5-25
:STATus:QUEStionable:ENABle <numeric_value>	5-26
:STATus:QUEStionable[:EVENT]?	5-26
SYSTEM Subsystem	5-27
:SYSTEM:BEEPer[:IMMediate]	5-27
:SYSTEM:BEEPer:STATe { ON OFF 1 0 }	5-27
:SYSTEM:ERRor?	5-27
:SYSTEM:KLOCK { ON OFF 1 0 }	5-27
:SYSTEM:LFRequency <numeric_value>	5-27
:SYSTEM:PRESet	5-28
:SYSTEM:VERSion?	5-28
TRIGger Subsystem	5-29

:TRIGger[:SEQuence1]:COUnT <numeric_value>	5-29
:TRIGger[:SEQuence1]:DELAy <numeric_value>[MS S]	5-29
:TRIGger[:SEQuence1][:IMMediate]	5-29
:TRIGger[:SEQuence1]:SOURce {BUS EXTErnal INTErnal MANual TIMER}	5-30
:TRIGger[:SEQuence1]:TIMer <numeric_value>[MS S]	5-30
Common Commands	5-31
*CLS	5-31
*ESE <numeric_value>	5-31
*ESR?	5-31
*IDN?	5-31
*LRN?	5-31
*OPC	5-31
*RCL <numeric_value>	5-31
*RST	5-32
*SAV <numeric_value>	5-32
*SRE <numeric_value>	5-32
*STB?	5-32
*TRG	5-32
*TST?	5-33
*WAI	5-33
Status Reporting Structure	5-34
Service Request (SRQ)	5-34
Status Byte Register	5-35
Standard Event Status Register	5-36
Standard Operation Status Group	5-37
Operation Status Register	5-38
Questionable Status Register	5-38
Trigger System	5-39
HP 4339A Trigger System Configuration	5-39
Idle State	5-40
Initiate State	5-40
ARM Event Detection State	5-40
TRIG Event Detection State	5-41
Sequence Operation State	5-41
Data Transfer Format	5-42
ASCIi	5-42
REAL	5-43
Command Summary	5-44

6. Application Measurement

Introduction	6-1
Measuring Insulation Resistance of Capacitors	6-2
Measuring Resistivity of Insulation Materials	6-5
Measuring Insulation Resistance Time Characteristics of Electro-Mechanical Components	6-9

7. Measurement Basics	
Introduction	7-1
Insulation Resistance Measurement	7-2
Residual Charge Effect	7-2
Absorption Phenomena	7-2
Voltage Coefficient and Temperature Coefficient	7-2
Shielding	7-2
Resistivity	7-3
Volume Resistivity	7-3
Surface Resistivity	7-4
High Capacitance DUT Measurement	7-5
8. Specifications	
Specifications	8-2
Measurement Parameters	8-2
Measurement Conditions	8-2
DC Test Voltage (Vs)	8-2
Ammeter	8-2
Test Cable Length	8-2
Measurement Time Mode	8-2
Ranging	8-2
Averaging	8-2
Trigger Mode	8-3
Trigger Delay Time	8-3
Measurement Range	8-3
Measurement Accuracy	8-4
Measurement Support Functions	8-6
Display	8-6
Correction	8-6
Test Sequence Program:	8-6
Mathematical Functions	8-6
Comparator	8-6
Contact Check	8-6
HP-IB Interface	8-6
Handler Interface	8-6
Save/Recall	8-6
Continuous Memory Capability	8-7
Key Lock	8-7
General	8-7
Power Requirements	8-7
Operating Temperature and Humidity	8-7
Storage Temperature and Humidity	8-7
Dimensions	8-7
Weight	8-7
Supplemental Performance Characteristics	8-8
Typical Measurement Accuracy	8-8
Measurement Time	8-8
DC Test Voltage Settling	8-9
DC Test Voltage Output Resistance	8-9
Contact Check Required Conditions	8-9
Continuous Memory Duration	8-9
Safety Considerations	8-9

9. Maintenance	
Introduction	9-1
Test Equipment	9-1
Performance Tests	9-2
Introduction	9-2
Test Equipment	9-2
Calculation Sheet	9-2
Performance Test Record	9-3
Calibration Cycle	9-3
Source Voltage Accuracy Test	9-4
Specification	9-4
Test Equipment	9-4
Procedure	9-4
Ammeter Offset Voltage and Input Resistance Test	9-6
Specification	9-6
Test Equipment	9-6
Procedure	9-6
Ammeter Offset Voltage Test	9-6
Ammeter Input Resistance Test	9-7
Current Measurement Accuracy Test	9-9
Specification	9-9
Test Equipment	9-9
Procedure	9-9
Resistance Measurement Accuracy Test	9-13
Specification	9-13
Test Equipment	9-13
Procedure	9-13
Resistance Measurement Accuracy Test (Floating Device)	9-13
Resistance Measurement Accuracy Test (Grounded Device)	9-16
Calculation Sheet	9-19
Source Voltage Accuracy Test	9-19
Ammeter Input Resistance Test	9-19
RC Box Calibration Values	9-19
Current Measurement Accuracy Test	9-20
Resistance Measurement Accuracy Test	9-20
Performance Test Record	9-21
Source Voltage Accuracy Test	9-21
Ammeter Offset Voltage and Input Resistance Test	9-21
Current Measurement Accuracy Test	9-22
Resistance Measurement Accuracy Test	9-22
Functional Test	9-23
Introduction	9-23
Test Equipment	9-23
Handler Interface Functional Test	9-24
Test Equipment	9-24
Procedure	9-24
Initial Setup	9-24
Key Lock Function Test	9-24
External Trigger Function Test	9-24
Handler Interface Output Test	9-25
Contact Check Functional Test	9-26
Test Equipment	9-26
Procedure	9-26

1. The first part of the document discusses the importance of maintaining accurate records of all transactions and activities. It emphasizes the need for transparency and accountability in financial reporting.

2. The second part of the document outlines the various methods used to collect and analyze data. It includes a detailed description of the sampling process and the statistical techniques employed to ensure the reliability of the results.

3. The third part of the document presents the findings of the study. It shows that there is a significant correlation between the variables being studied, and that the results are consistent across different groups and time periods.

4. The fourth part of the document discusses the implications of the findings and offers suggestions for further research. It highlights the need for continued monitoring and evaluation of the system to ensure its effectiveness and efficiency.

5. The fifth part of the document provides a summary of the key points and conclusions. It reiterates the importance of the findings and the need for continued attention to the issues discussed.

Getting Started

Introduction

This chapter provides information to get you started using your HP 4339A High Resistance Meter. This chapter discusses the following topics:

- Overview
- Initial Inspection
- Preparation for Use
- Using the Front-Panel Keys
- Basic Operation

Overview

The HP 4339A High Resistance Meter is designed for measuring very high resistance and related parameters of insulation materials, electronic components, and elector-mechanical components.

Features

- Measurement Parameters:
 - Resistance (R)
 - Volume Resistivity (ρ_v)
 - Surface Resistivity (ρ_s)
 - Current (I)
- Test Voltage : 0.1 to 1000 Vdc
- R Measurement Range: 10^3 to $1.6 \times 10^{16} \Omega$
- Basic Accuracy: 0.6 %
- High speed measurement: 10 ms
- High speed contact check
- Built-in comparator
- Inter face: HP-IB and handler interfaces

The HP 4339A's measurement range is from $1.0 \times 10^3 \Omega$ to $1.6 \times 10^{16} \Omega$. This wide range allows accurate high resistance measurements of capacitors, relays, switches, connectors, materials, cables, and PC boards.

The HP 4339A has the capability to measure grounded DUTs (Device Under Test), which gives you the ability to measure and evaluate devices such as PC board patterns. The HP 16008B resistivity cell and the HP 16339A component test fixture are designed for stable and safe measurements of materials or components.

The Measurement Sequence Program function allows you to control a series of resistance measurements in a sequence (charge-measure-discharge). You can set the charge time, measurement interval time, and the number of measurements in a sequence from the front panel.

Surface resistivity (ρ_s) and volume resistivity (ρ_v) are calculated automatically and result is displayed.

The 10 ms measurement time, 2 ms high-speed contact check function, built-in comparator, and HP-IB/handler interface deliver a high speed test throughput for production environments.

HP 4339A

Overview

Accessories Available

The following accessories are available for the HP 4339A:

- HP 16339A** Component Test Fixture: For lead, chip, or other types of components.
- HP 16008B** Resistivity Cell: For resistivity measurement of solid sheet materials. Two optional electrode sizes can be ordered in addition to the installed standard 50 mm diameter electrode.
- Option 001: Add 26/78mm diameter electrodes
Option 002: Add 26mm diameter electrode
Option 003: Add 78mm diameter electrode
- HP 16117B** Low Noise Test Leads (1 m) : Alligator clip leads.
- HP 16117C** Low Noise Test Leads (1 m) : A Set of male-male triaxial and BNC cables, and an interlock cable. Female-triaxial and Female BNC connectors are also included.
- HP 16064B** LED display/trigger box : Displays comparator status and allows manual triggering.

Options Available

- Option 008** Add Japanese Operation Manual
- Option 009** Delete English Operation Manual
- Option 910** Extra English Operation Manual
- Option ABD** User's Guide in German
- Option ABE** User's Guide in Spanish
- Option ABF** User's Guide in French
- Option 0B3** Add Service Manual
- Option 907** Front Handle Kit
- Option 908** Rack Mount Kit
- Option W30** 3-Year Customer-Return Repair
- Option W32** 3-Year Customer-Return Calibration
- Option W34** 3-Year Customer-Return, Standard-Compliant Calibration

Front Panel

This section gives a guided tour of the front panel. For a detailed description of each key's function, refer to Chapter 3.

Each description starting with (Shift) is the secondary function of the key, which is available by pressing the blue shift key (refer to "Shift Key").

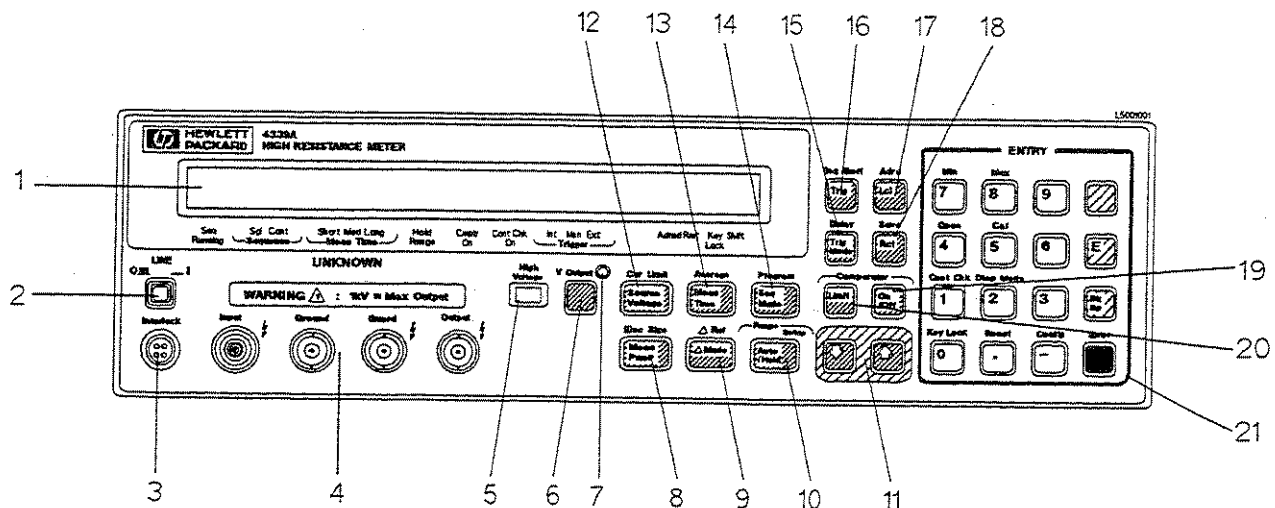

1. **Display** displays measurement results, instrument states, and error messages.
2. **LINE Switch** turns the HP 4339A ON and OFF.
3. **Interlock Connector** provides safety from high voltages and identifies which test fixture is connected.
4. **UNKNOWN Terminal** is the connection port of the test fixture.
5. **High Voltage Indicator** indicates that the HP 4339A is outputting dangerous voltage levels up to 1000 Vdc.
6. **Voltage Output Key** applies test voltage to DUT.
7. **Voltage Output Indicator** indicates when voltage is applied at Output terminal.
8. **Measurement Parameter Key** selects the measurement parameter.
(Shift) **Electrode Size Key** defines the size of the test fixture electrode.
9. **Δ Mode Key** selects the deviation measurement mode.
(Shift) **Δ Reference Key** sets the nominal value to be used in a deviation measurement.
10. **Auto/Hold Key** toggles the measurement range mode between Auto and Hold.
(Shift) **Range Setup Key** selects the measurement range.
11. **Down and Up Arrow Keys** increases or decreases the setting value.
12. **Source Voltage Key** sets value of the applied voltage.
(Shift) **Current Limit Key** sets the limit value of the current through the DUT.
13. **Measurement Time Key** selects measurement time mode of Short, Medium, or Long.
(Shift) **Average key** sets the averaging rate.
14. **Measurement Sequence Mode Key** selects the measurement sequence mode.
(Shift) **Program Key** sets the measurement sequence.

15. **Trigger Mode Key** selects the trigger source from Internal, Manual, or External.
(Shift) **Delay Key** sets the trigger delay time.
16. **Trigger Key** triggers a measurement in the Manual trigger mode.
(Shift) **Sequence Abort Key** cancels a measurement sequence.
17. **Local Key** cancels the HP-IB remote state.
(Shift) **Address Key** sets the HP-IB address.
18. **Recall Key** recalls instrument state data from the internal memory.
(Shift) **Save Key** stores instrument state data to the internal memory.
19. **Comparator On/Off Key** toggles the comparator function ON or OFF.
20. **Comparator Limit Key** sets the upper and lower limit values for the comparator function.

21. Entry Keys

- **7 Key / (Shift) Minimum Key** inputs the minimum value for a setting operation.
- **8 Key / (Shift) Maximum Key** enters the maximum value for a setting operation.
- **9 Key**
- **Shift Key** activates the secondary functions printed above the front-panel keys.

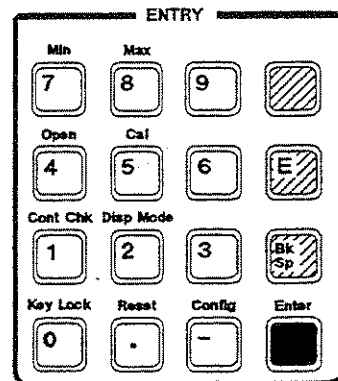

Note

In this manual, the blue Shift key is expressed as , even though the top of the key is not labeled with the word "blue".



- **4 Key / (Shift) Open Key** executes an OPEN correction.
- **5 Key / (Shift) Calibration Key** executes the calibration function.
- **6 Key**
- **Exponential Key** allows input of exponent value.
- **1 Key / (Shift) Contact Check Key** toggles the contact check function ON or OFF.
- **2 Key / (Shift) Display Mode Key** selects the display mode.
- **3 Key**
- **Back Space Key** erases the last character entered.
- **0 Key / (Shift) Key Lock Key** toggles to disable and enable the front panel key input.
- **. (point) Key / (Shift) Reset Key** resets the HP 4339A to its default state.
- **- (minus) Key / (Shift) Configuration Key** sets the offset-error canceling, beeper setting, and the power line frequency, and executes the internal test.
- **Enter Key** enters the input value to the HP 4339A.

Display

This section gives a guided tour of the display panel. For more detailed description of each item, refer to Chapter 3.

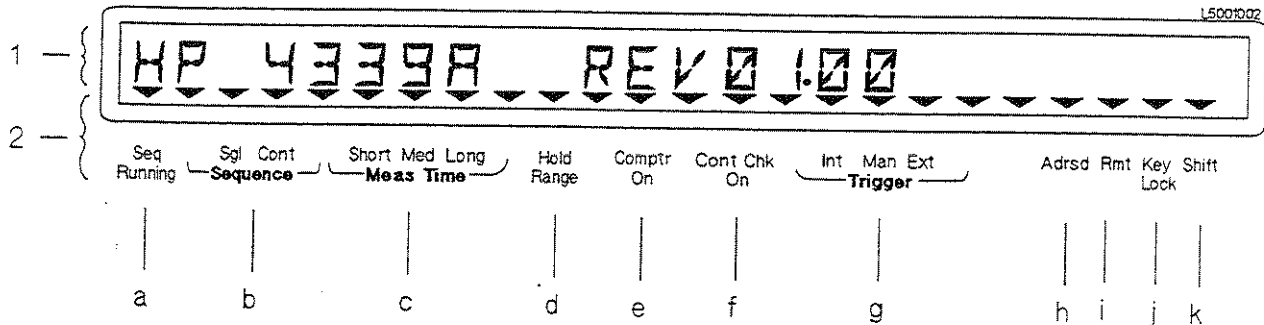

1. **Character Display Area** displays measurement result, instrument setting, and instrument messages.
2. **Annunciator** indicates instrument setting. Annunciator labels are as follows:
 - a. **Sequence Running** indicates a measurement sequence is running.
 - b. **Sequence** indicates measurement sequence mode is One-Shot (Sgl) or Interval (Cont) mode.
 - c. **Measurement Time** shows measurement time Short, Medium, or Long.
 - d. **Hold Range** indicates measurement range is in hold mode. When in Auto mode, the annunciator is not displayed. indicates state of range in hold mode. When in Auto mode, the annunciator is not displayed.
 - e. **Comparator On** indicates the comparator function is ON.
 - f. **Contact Check On** indicates the contact check function is ON.
 - g. **Trigger** indicates trigger mode is Internal (Int), Manual (Man), or External (Ext).
 - h. **Addressed** indicates the HP-IB state is Talker, Listener, or Talk Only.
 - i. **Remote** indicates the HP-IB state is remote.
 - j. **Key Lock** indicates the HP 4339A's front-panel keys are disabled.
 - k. **Shift** indicates that the shift toggle is activated.

Rear Panel

This section gives a tour of the rear panel. For a more detailed description of each item, refer to Chapter 3.

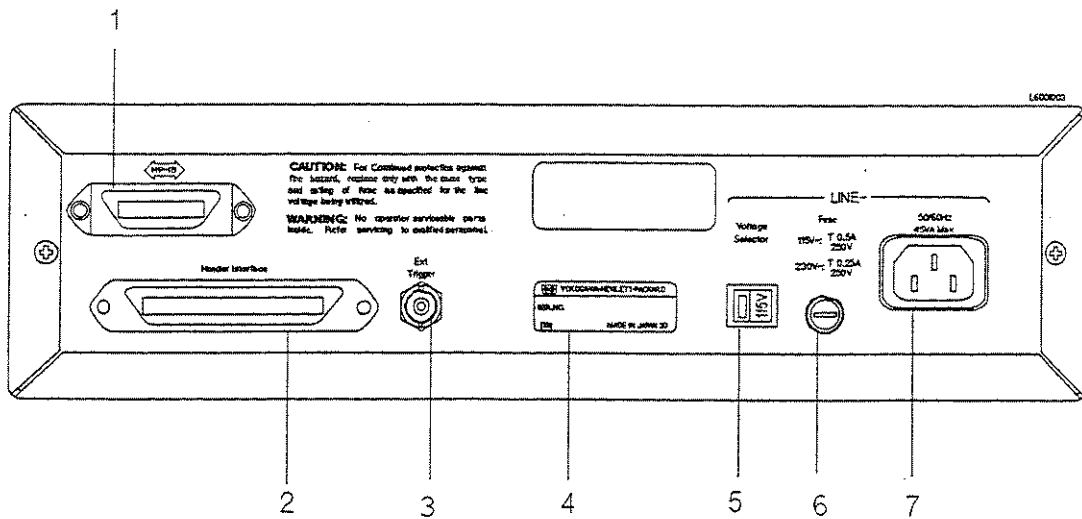

1. **HP-IB Interface** is used for controlling the HP 4339A from an external controller using HP-IB commands.
2. **Handler Interface** is used to synchronize timing with an external handler.
3. **Ext Trigger Terminal** is used to trigger a measurement using an external signal.
4. **Serial Number Plate** gives the instrument's manufacturing information.
5. **Line Voltage Selector Switch** is used to set the voltage to that of the AC power source.
6. **Line Fuse Holder**
7. **Power Cord Receptacle**

Initial Inspection

The HP 4339A has been carefully inspected both electrically and mechanically before being shipped from the factory. It should be in perfect physical condition, no scratches, dents or the like, and it should be in perfect electrical condition. Verify this by carefully performing an incoming inspection to check the instrument for signs of physical damage, missing contents and to check that it passes the electrical performance test. If any discrepancy is found, notify the carrier and Hewlett-Packard.

1. Inspect the shipping container for damage, and keep the shipping materials until the inspection is completed.
2. Verify that the shipping container contains everything listed below:
 - HP 4339A High Resistance Meter
 - Power cable
The HP Part number depends on the country where the HP 4339A is used. Refer to Figure 3-11.
 - Shunt connector
The HP part number is 04339-60003
 - Operation Manual (This book)
The HP Part Number is PN:04339-90000
 - User's Guide
The HP part number depends on the language in which the User's Guide is written, as follows:
 - English : 04339-90001
 - German : 04339-92001
 - French : 04339-93001
 - Spanish : 04339-96001
3. Inspect the exterior of the HP 4339A for any signs of damage.
4. Verify that the HP 4339A is equipped with the options you ordered.
5. Complete the "Preparation for Use" procedures described in the next section.
6. Perform the Performance Test, described in Chapter 9, to verify the HP 4339A's electrical performance.

Preparation for Use

Before you use the HP 4339A, you must set it to match the available power line voltage and frequency.

- Set power line voltage—refer to “Power Requirements”.
- Set power line frequency—refer to “Turning ON the HP 4339A”

Power Requirements

The HP 4339A requires a following power source:



Line Voltage : 100 / 120 / 220 / 240 V ac ($\pm 10\%$)

Line Frequency : 47 to 66 Hz

Power Consumption : 45 VA maximum

Confirm that the LINE Voltage Selector on the rear panel is set to match the power line voltage before plugging in the HP 4339A. Refer to Table 1-1.

Table 1-1. Power Voltage Selector Setting

Voltage Selector	Line Voltage	Required Fuse
	100 V / 120 V	T 0.5 A 250 V (HP part number 2110-0202)
	220 V / 240 V	T 0.25 A 250 V (HP part number 2110-0201)

To change the LINE voltage setting of the HP 4339A:



1. Confirm power cable is disconnected.
2. Slide the LINE Voltage selector on the rear panel to match the ac line voltage. (refer to Table 1-1.)

Turning ON the HP 4339A

1. Connect the power cable to Power Cord Receptacle on the rear panel.
2. Push the LINE switch in and the HP 4339A will emit a beep. All digits are displayed while the self test is in progress. (If any message is displayed, refer to the “Messages” in the back of this manual.) The HP 4339A will be ready for operation after a message similar to the one shown in the following figure is displayed.





3. When you turn on the HP 4339A for the first time, confirm the power line frequency is set correctly.

a. Press  . The following is displayed.

1500034

OFST BEEP LINE MORE EXIT

b. Press  until LINE blinks, then press .

1500034

LINE FREQ: 50HZ 60HZ



A blinking item means that it is currently selected.

c. If the setting does not match the ac line frequency, press  to toggle the setting between 50 HZ and 60 HZ.

d. Press  two times to exit this menu.

The power line frequency setting is stored and is not changed after reset or power-off. Once you set it, you do not need to set the line frequency again as long as the same power line frequency is being used.

Power-On Self Test

When turned on, the HP 4339A performs self test which checks basic operation of the analog and digital circuits, display, LED, and Beeper. If an error is detected, an error message will be displayed on the LCD. For more information, refer to "Configuration Key   " in Chapter 3.

Warning



Before turning the HP 4339A OFF, the High Voltage indicator must be OFF. When the High Voltage indicator is ON, wait until the High Voltage indicator is OFF. (When both the High Voltage indicator and the V Output indicator are ON, turn OFF the V Output first by pressing .)

Using Front Panel Keys

The HP 4339A has four types of keys as follows:

- Direct Execution Type Keys
- Toggle Type Keys
- Selection Type Keys
- Value Setup Type Keys



Note



If you want to exit an operation and go back to the measurement mode, press  several times until you are back to the measurement mode.

Direct Execution Type Keys

Pressing a direct execution key performs the pressed key's function immediately. For example,



press   and the HP 4339A will begin an OPEN correction immediately.

Toggle Type Keys

Pressing a toggle type key will switch the setting. An annunciator indicates the current setting. For example,

Press  and the **Meas Time** annunciator moves to the next measurement time mode.





Selection Type Keys

Pressing a selection type key will display a menu or choice available for that key. The blinking item is the one currently selected. By using , , or the selection key itself, the item selected can be changed.





For example,

1. Press  . EXIT is blinking.

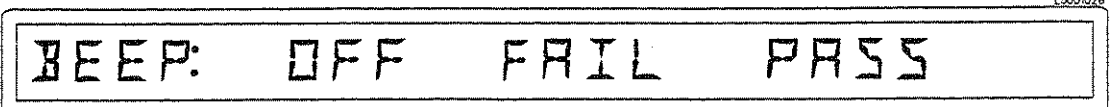

2. Press , , or  until BEEP blinks. Then press  and the beeper setup menu will be displayed.



3. Press , , or  to select. Press  to select the blinking item and go back to the previous menu display.

Using Front Panel Keys

HP 4339A

4. Press  to exit the menu.

Value Setup Type Keys

Pressing a value setup type key will display the parameter entry display and prompt you to enter a value.

For example, pressing  displays,

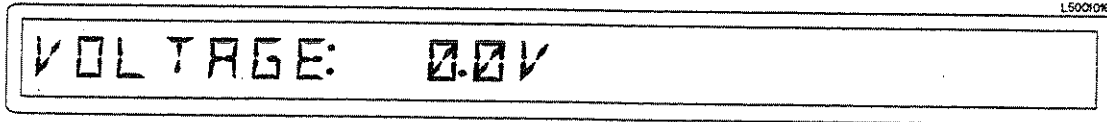

The displayed value can be entered/changed by using one of the following:

Numeric Keys

Maximum and Minimum Keys

Down and Up Arrow Keys

Back Space Key

Value Setup Using Numeric Keys

Some commands use numeric parameters. For example, to set the test voltage value to 100 V,

1. Press    .

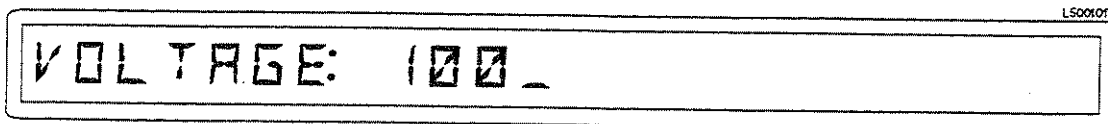

2. Press .

You can also enter numeric parameters using exponential notation.

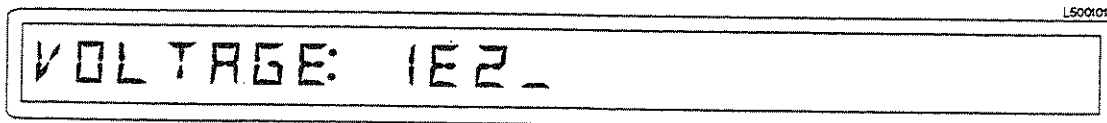

1. Press    .



2. Press .

Note



Before you press , the previous setting is still the current setting, even if the displayed value has changed. If you press a key other than one of the keys in the ENTRY block before pressing , the setting will not change and the displayed value will be discarded.

Value Setup Using Maximum and Minimum Keys

These keys enter the maximum and minimum numeric value in place of having to use the numeric keys. For example,

1. Press   .

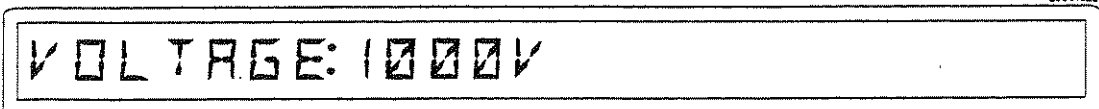

The maximum value of source voltage, 1000 V is displayed.

2. Press  .

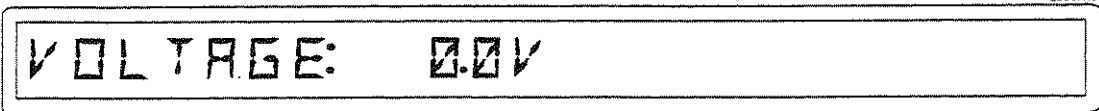



The minimum value of source voltage, 0.0 V is displayed.

3. Press .







Value Setup Using Down and Up Arrow Keys

Increases or decreases the numeric entry. For example,

1. Press   to select current limit menu.
2. Press  several times and confirm that the value changes.

Value Change Using Back Space Key

Erases the last character entered. For example,

1. Press  to select the source voltage menu.
2. Press     .

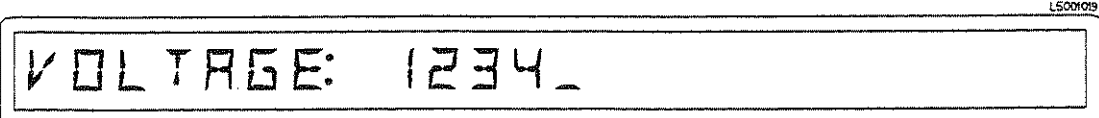

3. Press  and the last character entered, 4, is erased.

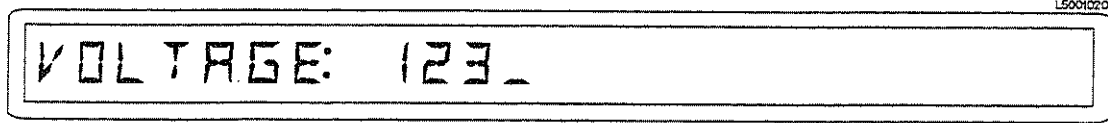

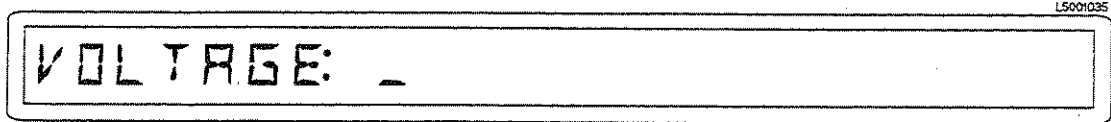

4. Press  three more times to clear the display.

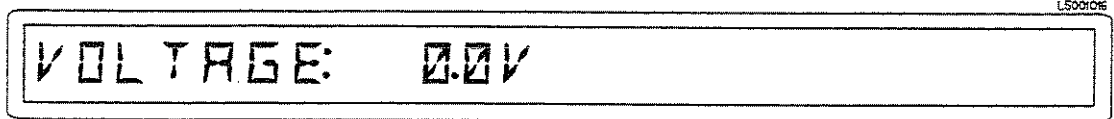

5. When the display is clear, press  once more and the previous setting is displayed.



6. Press  to exit this menu.

To cancel the input value, you can also skip step 5 and go to step 6, by pressing , after step 4. The following is displayed:



The input value is canceled and the setting is not changed, from the previous setting.

Basic Operation

This section provides the basic measurement procedure for the HP 4339A. Follow the instructions and become familiar with the HP 4339A's operation.

- Connecting Test Fixture
- Resetting HP 4339A
- Performing Calibration
- Performing OPEN Correction
- Selecting Measurement Parameter
- Setting Test Voltage
- Selecting Measurement Range
- Applying Test Voltage
- Turning OFF the Test Voltage

Note

If you have any problems while performing the procedures, refer to "If You Have a Problem" in Chapter 2.



Connecting Test Fixture

The HP 4339A has the capability to measure either floating or grounded DUTs. The measurement configuration is different for floating and grounded DUT measurements, and a Shunt connector is used to change the measurement configuration. Refer to the *Operation and Service Manual* of the test fixture for more information on how to connect it.

Warning



Do **NOT** touch the UNKNOWN terminals or the electrodes of the accessory. When the High Voltage indicator is ON, the HP 4339A outputs dangerous voltage level up to 1000 Vdc. Before handling the HP 4339A or the accessory, turn OFF the test voltage by pressing  and confirm that the High Voltage indicator is OFF.

Floating DUT Measurement

To measure a floating DUT, connect the DUT and shunt connector as shown below:

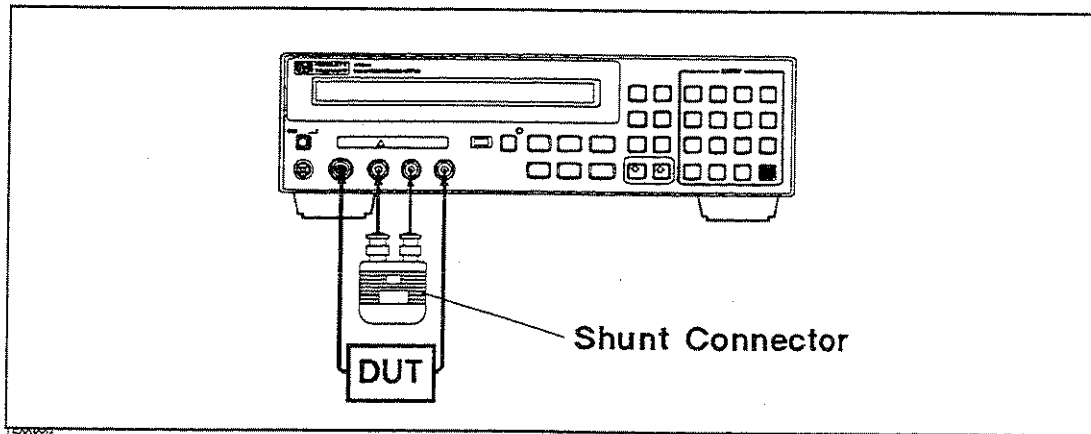

Figure 1-1. Floating DUT Measurement Configuration

Grounded DUT Measurement

To measure a grounded DUT, connect the DUT and shunt connector as shown below:

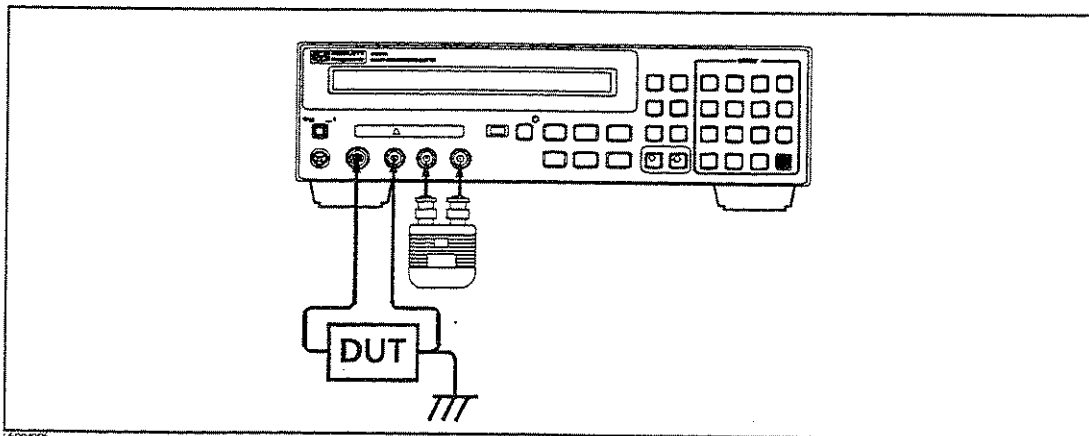





Figure 1-2. Grounded DUT Measurement Configuration



Resetting HP 4339A

Resetting the HP 4339A changes its settings to their default state.

1. Press   to select the reset menu.



SYSTEM RESET: YES NO

2. Press  to select YES (YES is blinking), then press .

For more information about the default state of the HP 4339A, refer to “Reset Key   ” in Chapter 3.

Performing Calibration

Calibration cancels measurement errors due to environmental temperature change.

1. Press  . The HP 4339A will display calibration message.

CALIBRATION

After displaying this message, the HP 4339A automatically performs the calibration and returns to the measurement display. The following message is displayed and the HP 4339A is ready to use.

CALIBRATION: COMPLETE



Note



If the message, CALIBRATION: FAILED, is displayed, refer to “If You Have a Problem” in Chapter 2.





Performing OPEN Correction

The OPEN correction function cancels measurement errors caused by residuals and stray capacitance of the test fixture and stores data for the contact check function.

1. Press , then enter the test voltage value using the entry keys.
2. Separate each electrode of the test fixture, confirming that nothing is connected to the electrodes. For details about fixture operation, refer to each fixture's *Operation and Service Manual*.
3. Press . A source voltage is applied to the test fixture, and the V Output indicator will turn ON.

Warning  Pressing  may cause the HP 4339A to output dangerous voltage, up to 1000 Vdc. Do *NOT* touch the UNKNOWN terminals or the electrodes of the fixture when the V Output indicator is ON.

4. Press  . The correction automatically begins and the following message is displayed.

1500100

OPEN CORRECTION

After a short time, the HP 4339A will return to the normal display with an end message as shown below. OPEN correction is completed.

1500101

CORR: COMPLETE

Note  If the message, OPEN CORR: FAILED, is displayed, confirm that the test fixture electrodes are completely separated.

5. Press . The source voltage is turned OFF, and the V Output indicator will be OFF.
6. Connect DUT to the electrodes.

Selecting Measurement Parameter

The HP 4339A has four measurement parameters, resistance, DC current, and surface and volume resistivity.

- To change the measurement parameter setting, press  and repeat until your desired parameter is displayed.

- Resistance : R

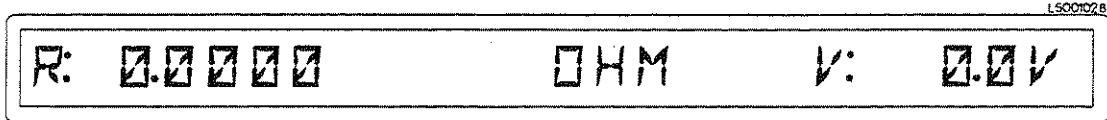

- Current : I

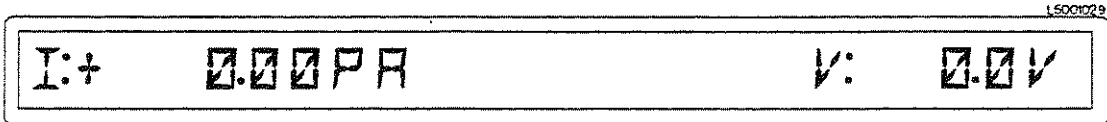

- Resistivity : RV or RS

Note



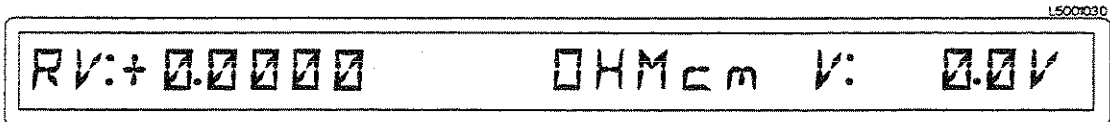

If the HP 16008B resistivity cell is connected to the HP 4339A, to change volume and surface resistivity, switch the volume/surface selector on the resistivity cell.

Volume Resistivity (ρ_v)

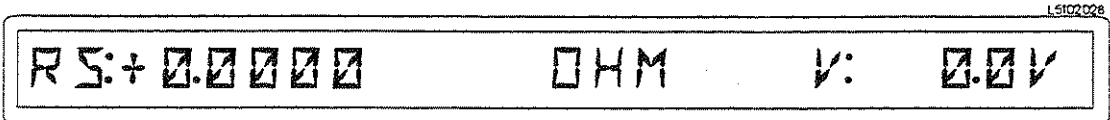

Surface Resistivity (ρ_s)





- Press  after displaying desired parameter.

Setting Test Voltage

The HP 4339A has an internal DC voltage source. To set voltage level of this source:

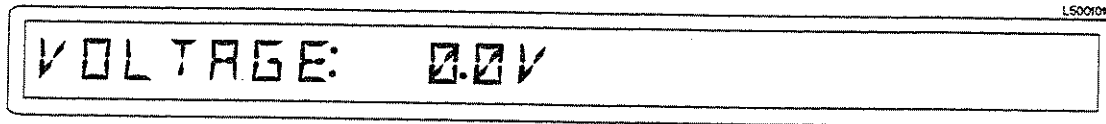
1. Press  to display the current voltage setting.



2. Enter the value using the entry keys, then press .

Selecting Measurement Range

The HP 4339A has two measurement range modes, Auto and Hold. Auto mode changes the measurement range automatically to fit the measured value. The Hold mode fixes the measurement range.

Auto Range mode

1. Press  and the **Hold Range** annunciator will turn OFF.

Hold Range mode



There are two ways to hold the measurement range:

Press  and the **Hold Range** annunciator will turn ON.

or,



Just press  or .

Changing the Range in Hold Range mode

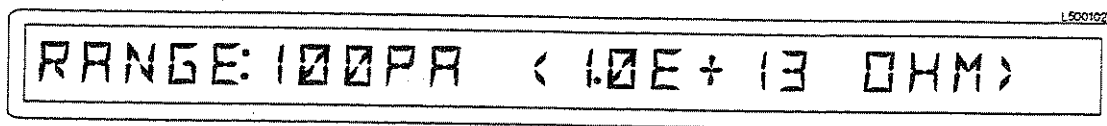
1. Press   to display the measurement range menu.



The value enclosed by angular brackets < > shows the upper limit value of resistance optimum range to be measured. (That value is calculated by the current value of the measurement range and source voltage value. If the source voltage setting is 0 V, the resistance value is not displayed.)

2. Press  or  until the desired range is displayed. Or, input the current value to be measured, and let the HP 4339A select the optimum measurement range setting.

HP 4339A

Turning OFF Test Voltage



3. press .

Applying Test Voltage

Press .

The source voltage specified using the  key is applied immediately, and the V Output indicator turns ON.

The displayed value is the valid measurement result when the applied source voltage is applied.

Warning  Pressing  may output dangerous voltage level up to 1000 Vdc. Do *NOT* touch the UNKNOWN terminals or the electrodes of the fixture when the V Output indicator is ON.

Turning OFF Test Voltage

Press .

The V Output indicator will turn OFF.

Warning  If the High Voltage Indicator turns ON after turning OFF the test voltage, the DUT is still charged. This happens especially for capacitive DUTs. Do *NOT* handle the DUT while the High Voltage Indicator is turned ON. When the charge on the DUT discharges to a safe level (less than 42 V), the High Voltage indicator will turn OFF.

Vertical text or markings along the right edge of the page, possibly bleed-through or a margin note.

Operating the HP 4339A

Introduction

This chapter provides step-by-step instructions for using the HP 4339A High Resistance Meter.

It includes the following sections:

- Measurement Configuration
- Making a Measurement
- Testing the HP 4339A
- If You Have a Problem

Refer to Chapter 3 for the description of each front panel key function.

Measurement Configuration

This section discusses the HP 4339A's general configuration topics that apply to all measurement functions.

Selecting the Measurement Time Mode

The current measurement time mode setting is indicated by the annunciator. To select the measurement time mode:

Press  until the measurement time mode is set to the desired value.

Setting the Averaging Rate

To set the averaging time or to show the current setting:

1. Press  .

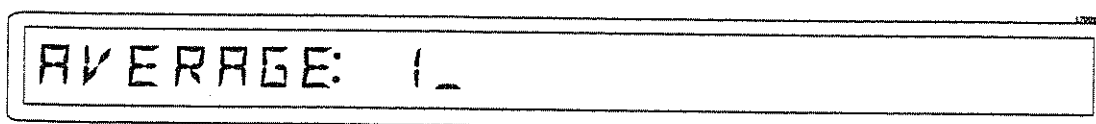



2. Enter the desired value. When you just want to show the current setting, do nothing.
3. Press  to set the value and to exit.

Setting the Trigger Delay Time

To set the trigger delay time or to show the current setting:

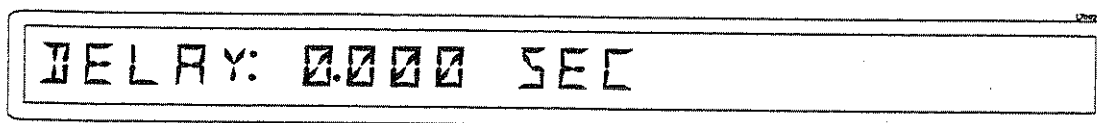
1. Press  .



2. Enter the desired value. When you just want to show the current setting, do nothing.
3. Press  to set the value and to exit.

Setting the Parameters for Resistivity Measurement

To set the parameters to calculate the resistivities or to show the current setting (DUT thickness, Electrode Size):

Press  .

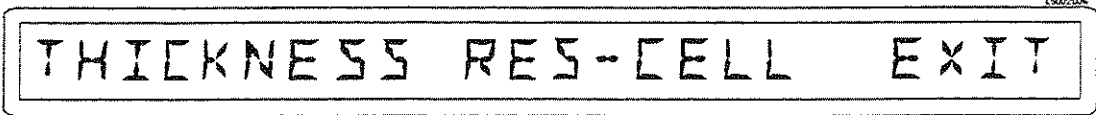



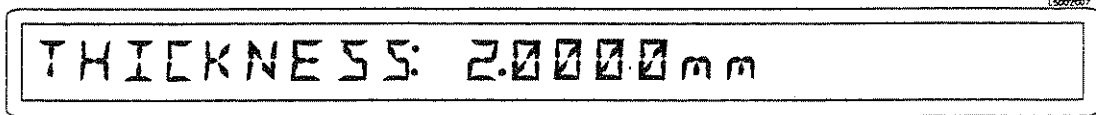

Entering Thickness of the DUT

To enter the thickness of the DUT or to show the current setting:

1. Select THICKNESS using  or , and press .





2. Enter the desired value, or leave the current setting. Press .
3. To exit, select EXIT using  or , then press , or proceed to setting Electrode Size.

2 Operating the HP 4339A



Setting the Electrode Size

- To set the electrode size or to show the current setting:

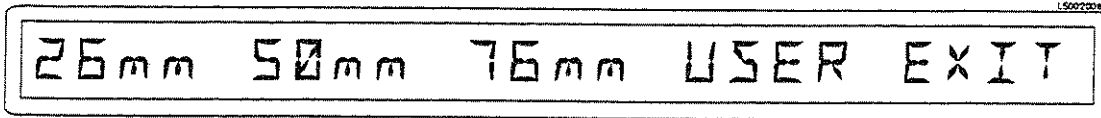
1. Select RES-CELL using  or .





- When You Use the HP 16008B Resistivity Cell

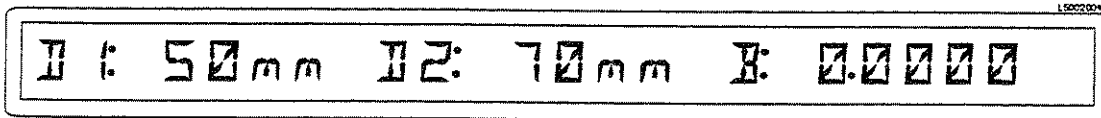

1. Select the electrode size that you want to use (26mm, 50mm, or 76mm) using  or , and press . For example, when you select 50mm, the following will be displayed.



Where, D1 is the main electrode diameter, D2 is the guard ring diameter, and B is the effective surface coefficient which is the fraction of the gap width to be added to the diameter of the electrode.



2. To change B value, enter the desired new value, then press  to enter the value and to exit. Or leave the current setting and press  to exit.

- When You Use Your Own Resistivity Cell

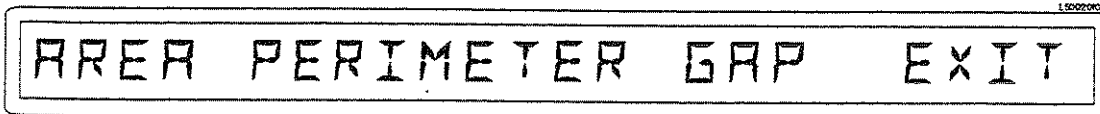
1. Select USER using  or  and press .



2. To set the effective area value,

- a. Select AREA using  or  and press .

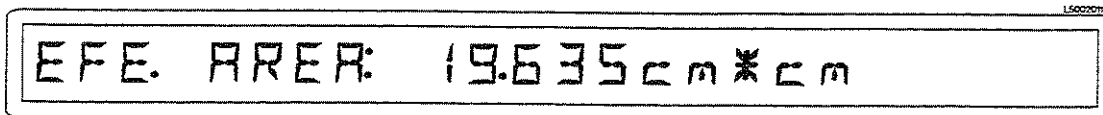

b. Enter the value, then press  to enter the value and to exit.

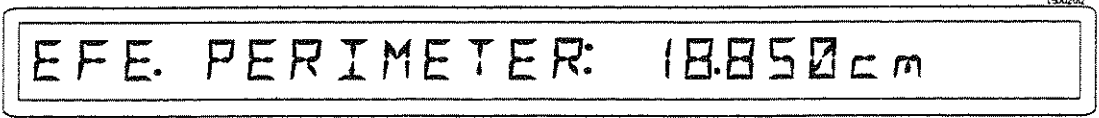

3. To set the effective perimeter value,

a. Select PERIMETER using  or  and press .





b. Enter the value, then press  to enter the value and to exit.

4. To set the gap value,

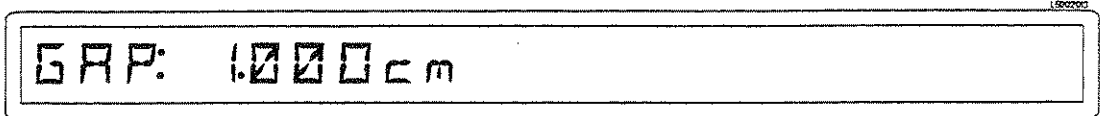
a. Select GAP using  or  and press .



b. Enter the value, then press  to enter the value and to exit.

5. To exit, select EXIT using  or  and press .

2 Operating the HP 4339A

Making a Measurement

Triggering a Measurement

The HP 4339A has four trigger source modes: Internal, Manual, External, or Bus. The **Trigger** annunciator shows which trigger source is selected.

Note



When the bus trigger mode is selected, none of the **Trigger** annunciators are ON. The bus trigger mode can be set by HP-IB commands only.



■ To Trigger Internally

1. Press  until the **Int** trigger annunciator is ON.

■ To Trigger Manually

1. Press  until the **Man** trigger annunciator is ON.
2. Press  to trigger a measurement.

■ To Trigger Externally

1. Connect an external trigger source to the Ext Trigger terminal on the HP 4339A's rear panel.
2. Press  until the **Ext** trigger annunciator is ON.
3. Apply a TTL level trigger signal to trigger a measurement. (Refer to "External Trigger" in Chapter 3 for trigger spec's.)

Using the Comparator Function

The comparator function can be used to sort DUTs based on their parameter values. The **Comptr On** annunciator indicates whether the comparator function is set to ON or OFF.

■ To set the limit values:

1. Press .

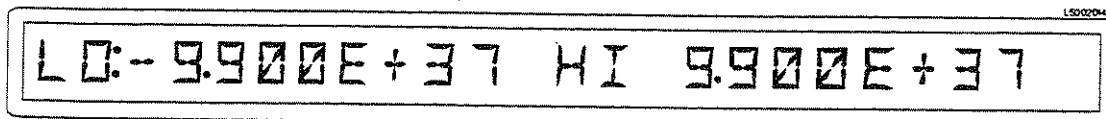

2. A blinking LO shows that you can enter the lower limit value.

Enter the value, then press .

If you do not want to change the lower value but want to set the upper limit value, press .

When you want to exit without changing the value, just press  twice.

3. A blinking HI shows that you can enter the upper limit value.





Enter the value, then press .



When you do not want to change the upper limit value but want to go back to the lower limit value, press .

When you want to exit without changing either value, just press  twice.

Note





When you want to set the limits only for the lower limit or the upper limit, or the limits only for the primary parameter or the secondary parameter, set the unnecessary parameter OFF by using the   (setting the minimum value) or the   (setting the maximum value).

For example, when you do not want to set the lower limit, press   while LO is blinking.

■ To start sorting:

Press .

■ To display the sorting results:

Press   until you reach your desired display.

□ The Measurement Display mode shows the measured data:

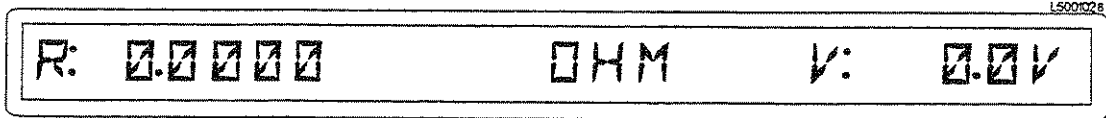

□ The Comparison Display mode shows the comparison results (HIGH, LOW, or IN):

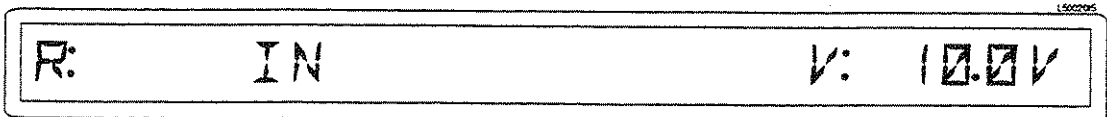

- The Limit Table display shows the comparator limits:

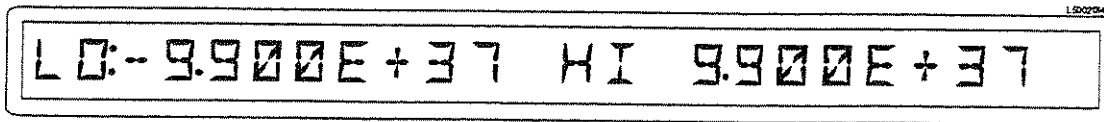

- The Display OFF mode shows the annunciators only.
- To stop sorting:
Press  .

Displaying Deviation Data





The Δ before the measurement parameter on the LCD display indicates that the displayed value for the parameter is a deviation value.

Setting the Reference Value

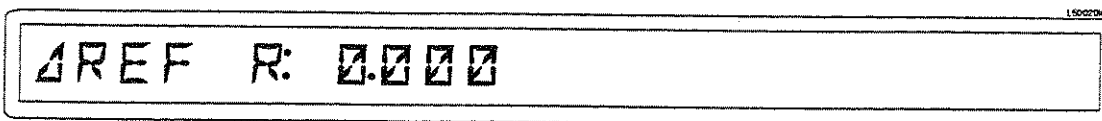
A reference value is needed for a deviation measurement. To set the reference value or to show the current setting:

1. Press   .



- To set by measuring a reference DUT:
Press  regardless of the trigger mode. Press  to enter the value and to exit.
- To set by entering a value:
Enter the value, then press  .
- I To exit without changing the value, just press  .

Selecting the Deviation Display Mode

To select the deviation display mode:

Press  until the desired mode is displayed.

- The Δ ABS mode displays the difference between the measured value and the reference value.



- The Δ % mode displays the difference between the measured value and the reference value as a percentage of the reference value.

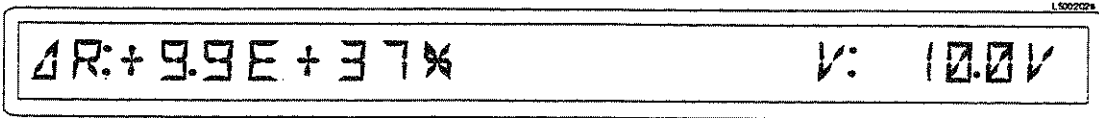

2 Operating the
HP 4339A

Using the Measurement Sequence Function



The measurement sequence function allows you to control a series of measurements in a sequence. Refer to "Measurement Sequence Mode Key  " in Chapter 3 for the details of the measurement sequence function.

Selecting the Measurement Sequence Mode

The HP 4339A has two sequence modes: the single (Sgl) mode and the continuous (Cont) mode. The current sequence mode setting is indicated by the annunciator. To select the sequence mode:

Press  until the desired sequence mode is selected.



Setting the Measurement Sequence Mode Parameters

1. Press   . The sequence mode menu will be displayed.



■ To Set Charge Time

To set the voltage charge time:

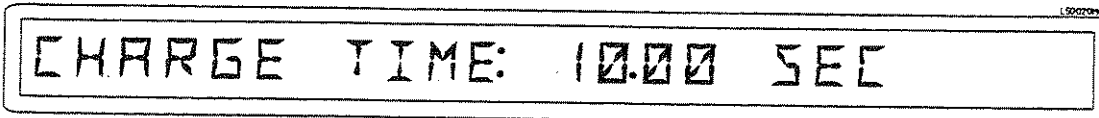

1. Select CHRG using  or  , then press  .





2. Enter the charge time, then press  .

■ To Set Interval Time

To set the measurement interval time used in the continuous mode:

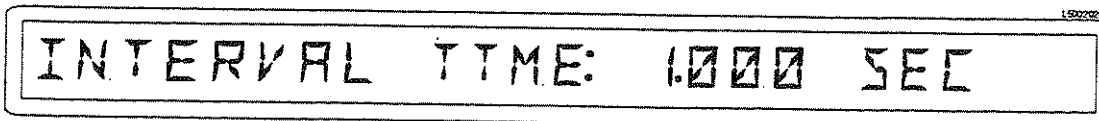

1. Select INTVL using  or  , then press  .



2. Enter the interval time, then press  .

■ To Set Number of Repetitions

To set the number of measurement points (equivalent to Memory Size) used in the continuous mode:

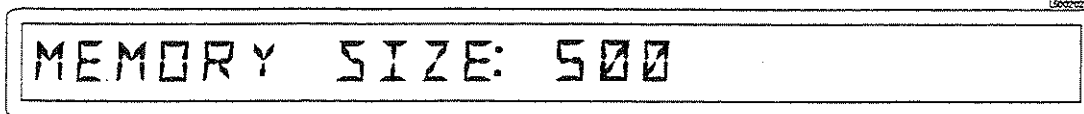

1. Select MEMORY using  or , then press .



2. Enter the number of measurement points, then press .

Starting Measurement Sequence

Press . The Seq Running annunciator is set to ON.

Warning  Pressing  may cause the HP 4339A to output dangerous voltage levels up to 1000 Vdc. Do *NOT* touch the UNKNOWN terminals or the electrodes of the accessory, when the V output indicator is ON.

Aborting Measurement Sequence

Press  . The Seq Running annunciator is set to OFF.

Setting Contact Check

The **Cont Chk On** annunciator tells the current contact check status.

Note Before performing the contact check, perform an OPEN correction to measure the reference values for the contact check. Refer to "Performing OPEN Correction" in Chapter 1.



- To set the contact check function.

Press  .

- To abort the contact check function.

Press   again.

Setting the Current Limit

To set the current limit or to show the current setting:

1. Press  .







2. Enter the value, then press .

Setting Beeper Mode

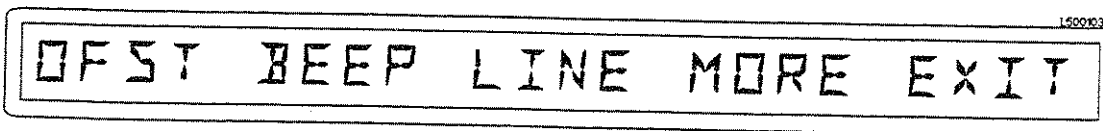

To set the beeper mode for comparator result reporting; OFF (not beeping), FAIL (beeping when the comparator result is HI or LO), or PASS (beeping when the comparator result is IN):

1. Press  .

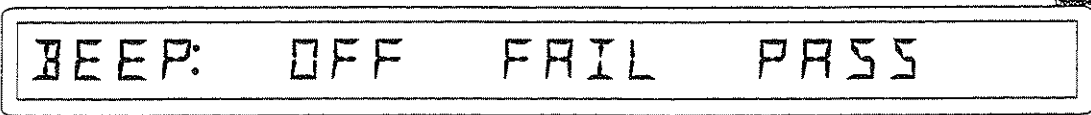

2. Select BEEP (BEEP blinking) using  or  and press .





3. Select the desired Beep mode using  or , and press .

4. To exit, select EXIT using  or , and press .

Saving and Recalling Instrument Settings

The HP 4339A can save and recall the instrument's settings into non-volatile memory (EEPROM).

- To save the current settings:

1. Press  .
2. Enter the register number (0 to 9) into which you want to save the settings.

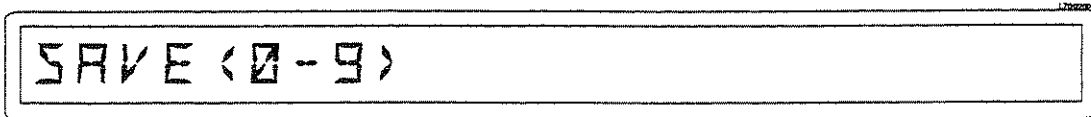

3. Press  to save.

Note Record the register number you used for future reference.



- To recall a setting.

1. Press .
2. Enter the register number (0 to 9) from which you want to recall the settings.

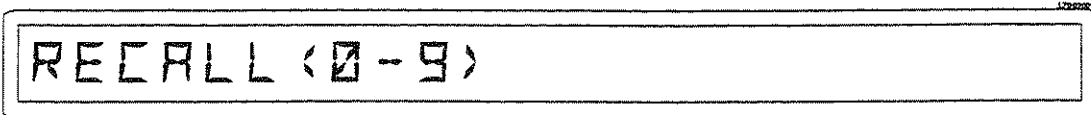



3. Press  to recall.

Locking Out the Front Panel Keys

To lockout the keys:

Press  .

To unlock the keys:

Press   again.

Selecting Local Mode

To return the HP 4339A to local mode from HP-IB remote mode:

Press .

Setting the HP-IB Address

1. Press  .

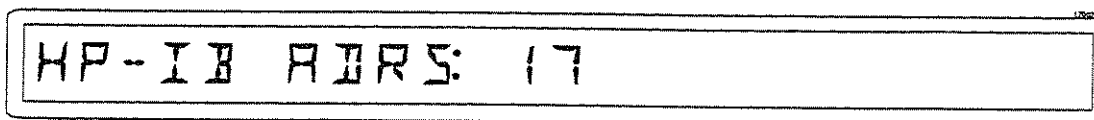





2. Enter the desired value, then press  to set the value and to exit.

When you just want to see the current setting, press .

Printing Measurement Data





The HP 4339A can print measurement data to an HP-IB compatible printer without using an external controller. To do so, you must:

1. Set the printer to listen-always mode. (Consult the printer manual for instructions.)
2. Connect the printer to the HP 4339A's HP-IB port.
3. Turn the printer ON.
4. Set the HP 4339A's HP-IB address to 31 (talk only mode).

Press     .

The printer will automatically begin printing the measurement data.

5. To stop printing, change the HP 4339A's HP-IB address to an address other than 31 (for example, 17, which is the default setting).

Press     .



Setting the Offset-Error Canceling Function

The offset-error calibration function cancels the offset error due to the temperature change, when the measurement range is 100 pA or 1 nA and the measurement time mode is Long. To turn the offset-error canceling function ON or OFF:

1. Press  .







L5001034

OFST BEEP LINE MORE EXIT

2. Select OFST using  or , and press .

L5002029

AUTO CANCEL: ON OFF

3. To select the offset-error canceling function ON or OFF, use  or , and press .
4. Select EXIT using  or , and press  to exit.

Using the HP 4339A with an Auto-Handler

When you use the HP 4339A with an auto-handler, configure the measurement system as shown in Figure 2-1.

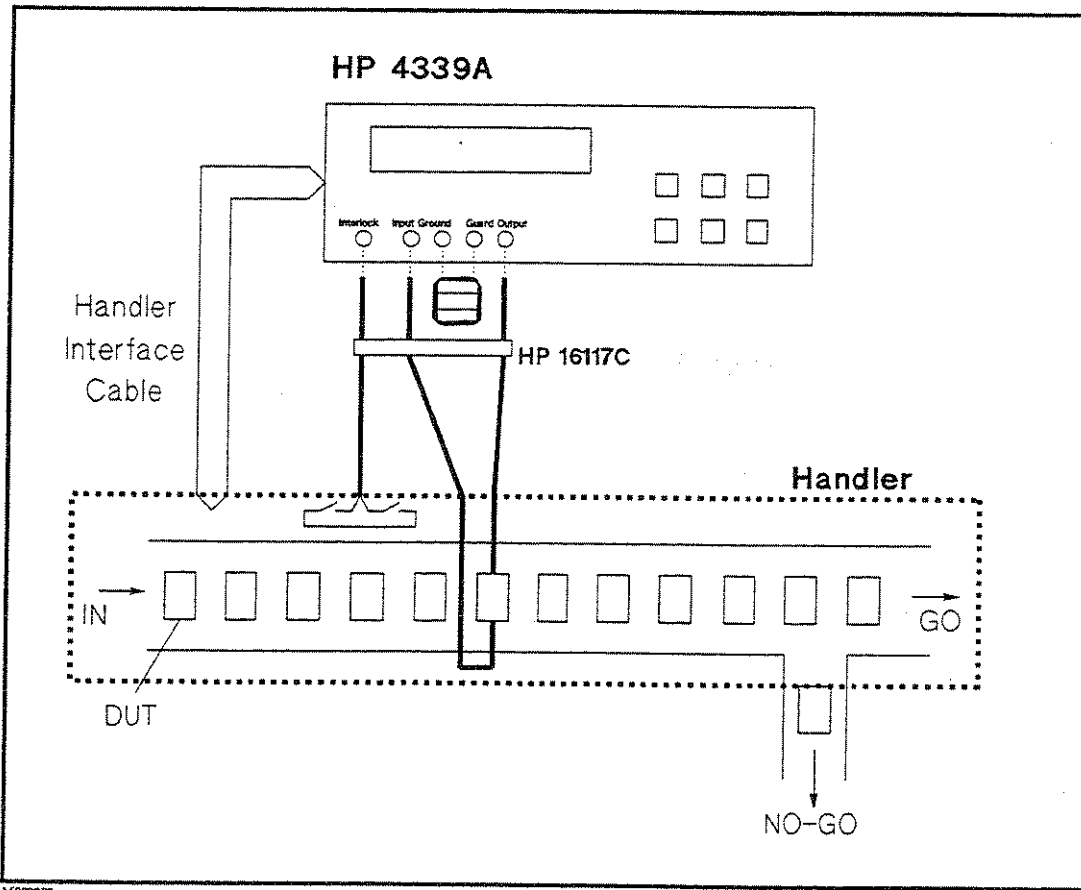

Figure 2-1. Using the HP 4339A with an Auto-Handler

1. Prepare the handler interface cable. Refer to "Handler Interface" in Chapter 3 for the pin assignments, the timing diagram, and the electrical characteristics of the handler interface.
2. Connect the HP 4339A and the handler using the HP 16117C Low Noise Test Leads. Refer to the *HP 16116C Operation and Service Manual* for the test leads configuration.

Testing the HP 4339A



Performing a Self-Test

The HP 4339A has a self-test function to check its basic performance.

1. Press  .





1500034

OFST BEEP LINE MORE EXIT

2. Select MORE using  or , then press .

1500034





SVC TEST EXIT

3. Select TEST using  or , then press  to execute the self test. If any error message is displayed, refer to "Error Messages."
4. Select EXIT and press  to exit.



Testing the Front Panel Key's Functionality

The HP 4339A has a service function to test the functionality of the front panel keys which this section describes.

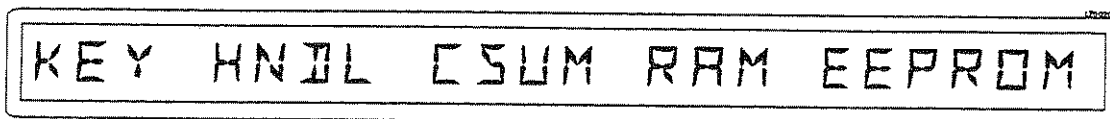

(There are another service functions which test the handler interface – refer to Chapter 9, and the ROM, RAM , and EEPROM – for use by service personnel only.)

1. Press  .
2. Select SVC using  or  and press .





3. Select KEY using , or  and press .

4. Press the front panel key that you want to test.

For example, when you want to test  ^{Seq Abort}, then press  ^{Seq Abort}.

When the key functions properly, KEY CODE:5 TRIGGER is displayed, otherwise, there will be no such display, and the key is not functioning correctly. Contact your nearest Hewlett-Packard office.

5. To exit the front panel key test, press  twice.
6. Then select EXIT and press  to exit.

If You Have a Problem

If the Display is Blank and the HP 4339A Appears Dead



If the display is blank, and even the annunciators are not ON:

- Check the fuse.

If an Error Message is Displayed



- Refer to “Messages.”

If the HP 4339A does not Accept Any Key Input

- Check whether the **Rmt** annunciator is ON.
 - Check whether the external controller is disabling all the front-panel controls using the LOCAL LOCKOUT command.
 - If so, send the LOCAL command from the external controller.
 - Press .
- Check whether the **Key Lock** annunciator is ON.
 - Check whether the handler or the HP 16064B LED display/trigger box is connected to the HP 4339A and it locks out the keys.
 - If so, unlock the keys from the handler or the HP 16064B.
 - Press  .

If the Display Displays Annunciators Only

The display mode is set to the Display OFF mode.



1. If the HP 4339A is in the remote mode or in the key lockout mode, cancel the.
2. Press   to change the display mode to a mode other than Display OFF.

If the Indicated Value is not Stable

- Shield the DUT to reduce the unwanted noise and the effect of operator proximity. For example, use the HP 16339A Component Test Fixture.
- Do not move the test leads while measuring. Changing the position of the test leads may cause noise inside the test leads.
- Position the HP 4339A on a stable place, where it will not be affected by vibration. Vibrating the HP 4339A may cause noise inside the HP 4339A.

If You Find Yourself Lost When Operating the HP 4339A

Press  until the HP 4339A returns to the measurement mode.

Or press   to return to the default settings.

Handwritten text, possibly bleed-through from the reverse side of the page. The text is oriented vertically and is extremely faint and illegible.

Function Reference

Introduction

This chapter provides information on all the HP 4339A's functions.

- Front Panel
- Rear Panel
- Theory of Operation

Front Panel

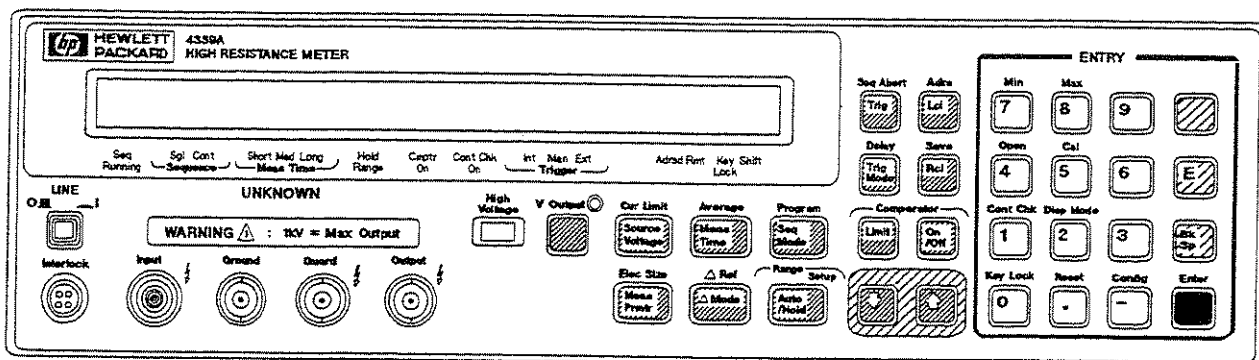





Figure 3-1. Front Panel

Note

In this manual, the blue shift key is expressed as , even though the top of the key is not labeled with the word “blue”.

Display

The display serves two functions – character display and annunciator display.

The character display shows the measurement result, instrument setting information, and instrument messages. The HP 4339A has four measurement display modes. For details about the display modes, refer to “Display Mode Key  ”.

Note

The character display is rewritten every 100 ms. So all the data may *not* be displayed on the character display when the measurement time mode is Short or Medium, because the measurement time of Short or Medium is less than 100 ms. However, all data is intact when output to the HP-IB interface or handler interface.

The annunciator (▼) points to the currently selected instrument settings. The annunciator labels are as follows:

- Seq Running** (Sequence Running) Indicates the measurement sequence is running.
- Sequence** Shows the measurement sequence mode – One-Shot (Sg1) or Continuous (Cont).
- Meas Time** (Measurement Time) Indicates measurement time mode – Short, Medium, or Long.
- Hold Range** Indicates the measurement range mode. when this annunciator is not lit, the HP 4339A is in Auto range mode.
- Comptr On** (Comparator On) Indicates the comparator function is ON.
- Cont Chk On** (Contact Check On) Indicates the contact check function is ON.
- Trigger** Indicates the trigger mode setting: Internal (Int), Manual (Man), or External (Ext).
- Adrds** (Addressed) Indicates that the HP 4339A is in the Talker, Listener, or Talk only state. This annunciator is active in HP-IB remote mode.

- Rmt** (Remote) Indicates that the HP 4339A is in HP-IB remote mode or the talk only mode.
- Key Lock** Indicates the HP 4339A's front panel keys are locked out.
- Shift** Indicates that the  is pressed. (Shift is active.)

LINE Switch

The LINE Switch turns the HP 4339A ON or OFF. Int the 1 (ON) position power is applied and all operating voltages are applied to the instrument. In the 0 (OFF) position no power is applied and no operating voltages are applied to the instrument.

The HP 4339A's settings are held in backup memory for about 72 hours after power is turned OFF. Refer to "Reset Key  " for the backed up settings.

Note  V Output ON /OFF state is not saved, and the HP 4339A sets the V Output to OFF at power-on.

Note  If you turn the HP 4339A OFF and then quickly ON again, it can cause an error and the HP 4339A may not work normally. To prevent this, wait for at least 1 second before turning ON again.

Interlock Connector

The HP 4339A's Interlock Connector provides safety from high voltages and identifies which test fixture is connected, It enables  which applies the test voltage to the test fixture, according to the following two tables.

Table 3-1. Interlock Condition for HP 16008B and HP 16339A

Interlock Connector	Interlock Switch ¹	Source Voltage
Not connected	—	Disabled
Connected	Open	Disabled
Connected	Closed	Enabled

¹ The condition whether the test fixture's cover is open or closed.

Table 3-2. Interlock Condition for HP 16117B Low Noise Test Leads

Interlock Connector	Source Voltage
Not connected	Disabled
Connected	Enabled ¹

¹ The available current limit setting is 0.5 mA only.

3 Function Reference

Measurement Sequence Mode Key 

The Measurement Sequence Mode key toggles the measurement sequence mode ON and OFF. This feature provides an automatic measurement process. The HP 4339A has two sequence modes: the single mode and the continuous mode.

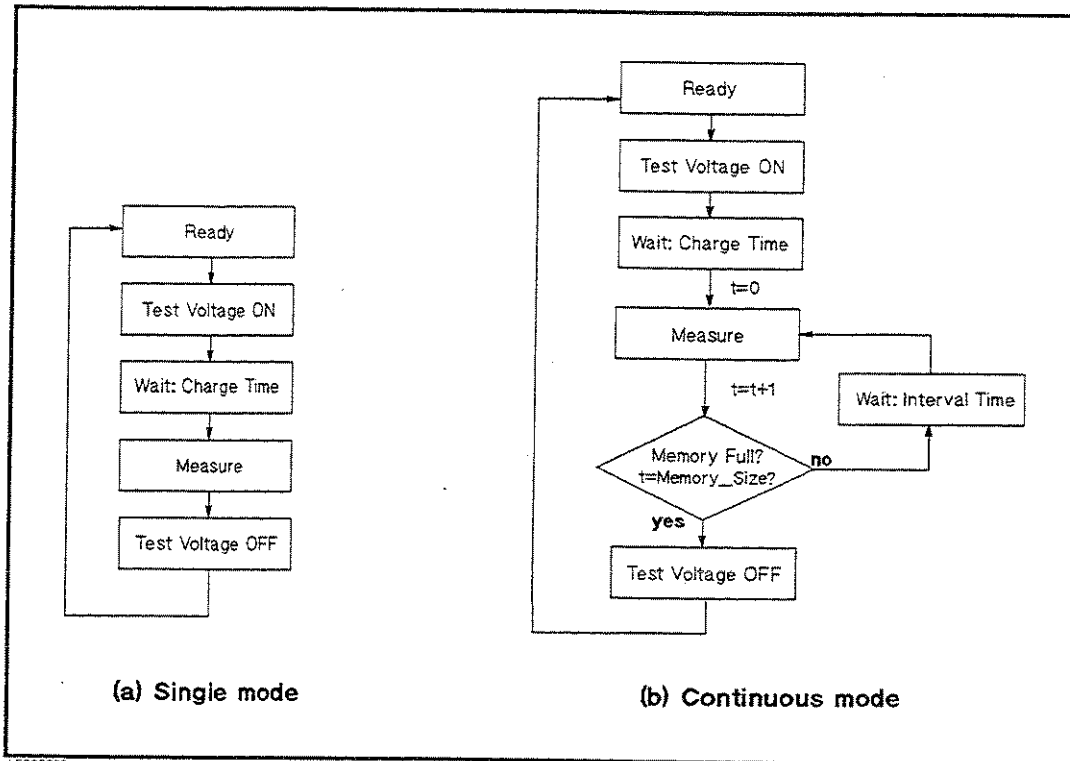



Figure 3-2. Sequence Mode

Single Mode





Figure 3-2(a) shows a measurement sequence in the Single mode. The single mode is appropriate for measuring a DUT when the operator defines the charge time (for example, 1 minute). The single mode is performed as follows:

1. At the Ready state, pressing  starts the measurement sequence, and the test voltage is turned ON.
2. The HP 4339A waits for the defined **Charge Time** while the applied voltage is charging the DUT.
3. After that, the HP 4339A measures the charged DUT.
4. At the end of the measurement sequence, the HP 4339A turns the test voltage OFF, and returns to the Ready state.

Continuous mode

Figure 3-2(b) shows a measurement sequence in the Continuous mode. The continuous mode is appropriate for measuring time related characteristics. The continuous mode is performed as follows:

1. At the Ready state, pressing  starts a measurement sequence, and the test voltage is turned ON.
2. The HP 4339A waits for the defined **Charge Time** while the applied voltage is charging the DUT.
3. After that, the HP 4339A repeats measuring the DUT as many times as is defined by the **Memory Size** with a defined **Interval Time** between measurements. The measurement data is displayed on the LCD display after each measurement, and all measurement data is stored in the data buffer, which can be accessed using HP=-IB commands (refer to DATA-sub).
4. After all measurements are completed, the HP 4339A turns the test voltage OFF, and returns to the Ready state.

The user definable parameters **Charge Time**, **Interval Time**, and **Memory Size**, are set using the program key ( ). For details, refer to "Program Key  ".

When the sequence is running, the **Seq Running** annunciator turns ON.

Program Key  

The program key sets the parameters for a measurement sequence. For details about the measurement sequence, refer to "Measurement Sequence Mode Key ". The measurement sequence parameters are as follows:

CHRG The Charging time of voltage. The range and resolution are as follows:

Range	Resolution
$0 \text{ s} \leq \text{Charge Time} < 1 \text{ s}$	1 ms
$1 \text{ s} \leq \text{Charge Time} < 10 \text{ s}$	10 ms
$10 \text{ s} \leq \text{Charge Time} < 100 \text{ s}$	100 ms
$100 \text{ s} \leq \text{Charge Time} \leq 999 \text{ s}$	1 s

The default setting is 0 ms.

INTVL The Interval Time (used only in the Continuous mode). The range and resolution are as follows:

Range	Resolution
$10 \text{ ms} \leq \text{Interval Time} < 1 \text{ s}$	1 ms
$1 \text{ s} \leq \text{Interval Time} < 10 \text{ s}$	10 ms
$10 \text{ s} \leq \text{Interval Time} < 100 \text{ s}$	100 ms
$100 \text{ s} \leq \text{Interval Time} \leq 999 \text{ s}$	1 s

The default setting is 1 s.

MEMORY The Memory Size (used only in the Continuous mode). This parameter is the number of measurement points which will be stored. Available memory sizes are 1 to 500. The default memory size is 500.



3 Function Reference

Measurement Parameter Key 

The Measurement Parameter key selects the measurement parameter for the HP 4339A from the following choices:

- R Resistance
- I Current — When measuring in the grounded DUT configuration, the measured current value is displayed as a negative value with the minus (-) sign.
- RS (ρ_s) Surface Resistivity
- RV (ρ_v) Volume Resistivity

The currently selected parameter is displayed on the left edge of the display. The default setting is R (Resistance).

Electrode Size Key  

The Electrodes Size key enters the thickness of the DUT, the electrode's size, and the effective area coefficient of the test fixture. These values are the factors used to calculate the volume or surface resistivity, which determine the volume resistivity or surface resistivity. Parameters are as follows:

- THICKNESS** Enters the DUT's thickness, which is equal to the distance between the electrodes. Available values are 0.01 mm to 20 mm, with 0.1 mm resolution. The default setting is 2.0 mm.
- RES-CELL** Defines the electrode's size and the effective area coefficient of the test fixture.
 - **26mm, 50mm, and 76mm** : Select the electrode diameter (D1) size when using the HP 16008B Resistivity Cell. The guard ring diameter size (D2) is automatically selected according to the D1 value. The effective area coefficient (B) is the fraction of the gap width to be added to the diameter of the electrodes. The B value is usually specified by the standard that you use. (for example: 1 for ASTM D 257; 0 for JIS K 6911).

Parameter	Description	Available Value		
D1	Main electrode diameter	26 mm ¹	50 mm ¹	76 mm ¹
D2	Guard ring diameter	38 mm ¹	70 mm ¹	88 mm ¹
B	Effective area coefficient	0 ≤ B ≤ 1 (0.01 resolution, default is 0)		

¹ These parameter's values are fixed and cannot be changed.

Surface resistivity (ρ_s) and volume resistivity (ρ_v) are calculated using the following equation:

$$\rho_s = \frac{\pi(D_2 + D_1)}{(D_2 - D_1)} \times R_s [\Omega]$$

$$\rho_v = \frac{\pi \times \left(D_1 + \frac{B(D_2 - D_1)}{2} \right)^2}{4t} \times \frac{R_v}{10} [\Omega \cdot cm]$$

Where,

R_s : Surface resistance (Measured value)

- R_v : Volume resistance (Measured value)
- t : DUT's thickness (Entered as THICKNESS)

■ **USER** Defines the electrode's parameters when using your own test fixture.

Parameter	Description	Available Value
AREA	Effective area	$0 \text{ cm}^2 \leq \text{AREA} \leq 9999.9 \text{ cm}^2$ (5-digit number, default is 19.635 cm)
PERIMETER	Effective perimeter	$0 \text{ cm} \leq \text{PERIMETER} \leq 999.99 \text{ cm}$ (5-digit number, default is 18.850 cm)
GAP	Gap	$0.001 \text{ cm} \leq \text{GAP} \leq 99.99 \text{ cm}$ (4-digit number, default is 1 cm)

Surface resistivity (ρ_s) and volume resistivity (ρ_v) are calculated using the following equation:

$$\rho_s = \frac{\text{PERIMETER}}{\text{GAP}} \times R_s [\Omega]$$

$$\rho_v = \frac{\text{AREA}}{t} \times \frac{R_v}{10} [\Omega \cdot \text{cm}]$$

Where,

- R_s : Surface resistance
- R_v : Volume resistance
- t : DUT's thickness (entered as THICKNESS)

3 Function Reference

Deviation Mode Key

The Deviation (Δ) Mode key selects the deviation measurement mode which displays the difference between the measured value and a reference value. The available deviation modes are as follows:

Δ ABS mode Displays the difference between the measured value and the reference value. The value is calculated by

$$\text{MeasuredValue} - \text{ReferenceValue}$$

Δ % mode Displays the difference between the measurement value and the reference value as a percentage of the reference value. The value is calculated by

$$\frac{\text{MeasuredValue} - \text{ReferenceValue}}{\text{ReferenceValue}} \times 100$$

Off Turns the deviation measurement mode OFF. (default)

Note Changing the measurement parameter sets the deviation mode to OFF.



Deviation (Δ) Reference Key

The deviation reference key sets the reference value of the deviation measurement. Refer to "Setting the Reference Value" in Chapter 2 for more information.

Auto/Hold Range Key

The Auto/Hold range key toggles the measurement ranging mode between Auto and Hold. In the Auto mode, the HP 4339A selects the optimum measurement range automatically within 5 measurement cycles. In the Hold mode, the HP 4339A measurement range is fixed at the range you select. The **Hold Range** annunciator indicates the current mode.

Range Setup Key



The Range Setup key sets the measurement range. The available measurement range settings are:

- 100 pA (available when the measurement time mode is Medium or Long)
- 1 nA
- 10 nA
- 100 nA
- 1 μ A
- 10 μ A
- 100 μ A (available when the measurement time mode is Short)

Each measurement range can measure a value up to 1.1 times of the range setup value. "OVLD"(Over Load) is displayed instead of the measurement data when the measured value is out of the measurable range.

Trigger Key

The trigger key triggers a measurement when the HP 4339A is in the Manual trigger mode. Refer to "Trigger Mode Key  " for more information.

Warning  When the measurement sequence mode is ON, pressing  may cause the HP 4339A to output dangerous voltage levels up to 1000 Vdc. Do **NOT** touch the UNKNOWN terminals or the electrodes of the accessory when the V Output indicator is ON.

Sequence Abort Key

The Sequence Abort key aborts the running measurement sequence program.

Local Key 

The local key returns the HP 4339A to local (front-panel) operation from HP-IB remote (computer controlled) operation. The Local key is the only active front-panel key while the HP 4339A is in HP-IB remote mode. When the HP 4339A is remote state, the **Rmt** annunciator will be displayed.

Address Key 

The Address key sets the HP 4339A's HP-IB address. The available HP-IB address is any integer number from 0 to 30, and address 31 is the Talk Only mode in which the HP 4339A only outputs data through HP-IB interface.

Resetting or powering off doesn't affect the HP 4339A's address setting.

Trigger Mode Key 

The Trigger Mode key selects the trigger source. The available trigger sources are as follows:

- Int** (Internal) Trigger Mode. The HP 4339A is triggered automatically and continuously. (Default)
- Man** (Manual) The HP 4339A is triggered when  is pressed.
- Ext** (External) The HP 4339A is triggered by a pulse input through the External Trigger terminal or the handler interface. Refer to "External Trigger".
- Bus** (Available only in HP-IB remote mode.) The HP 4339A is triggered by the GET or *TRG command through the HP-IB.

Delay Key 

The Delay key sets a lag time between event and the start of the actual measurement. The available trigger delay time value is 0 to 9.999 s.

Note The trigger delay time value is invalid when you perform the measurement sequence.



Recall Key 

The Recall key is used to recall instrument settings saved in non-volatile memory (EEPROM) (see "Save Key  "). You must enter register number, 0 to 9, from which to recall the settings. If the register selected is empty, the error message "RECALL FAILED" is displayed.





Save Key

The Save key stores the instrument's current settings into non-volatile memory (EEPROM). Saved settings are the same as the items stored into backup memory in Table 3-3. Up to 10 sets of instrument settings can be saved. You must enter the register number, 0 to 9, to assign the register into which the settings will be saved.

Caution  The HP 4339A overwrites the instrument's settings into the assigned register without warning. If settings are already stored in the assigned register, they will be lost.

Comparator Limit Key

The comparator limit key sets the comparator high and low limit values which decide the comparator's PASS or FAIL response. Note that the comparator function compares the displayed value with the limit values.

You cannot set each limit value to OFF using the front-panel keys, but you can by using HP-IB commands. (Refer to "CALCulate Subsystem" in Chapter 5 To get around this front-panel key restriction, use the Minimum ( ) or Maximum ( ) keys instead.

Comparator On/Off Key

The Comparator On/Off key toggles the comparator ON and OFF. The comparator determines the measurement result (displayed value) is within the upper and lower limits set by the Comparator Limit key. When the comparator is ON, the Comprtr On annunciator will be displayed. The comparator will yield one of the following results:

- HI** (high) Greater than upper limit
- IN** (in) Between the upper limit and lower limit
- LO** (low) Less than lower limit
- N.C.** (no-contact) Contact check failed (at contact check ON state)





In addition, these results are transmitted to the following destinations:

Destination	Condition
Display	HI, IN, LO, N.C.
Handler Interface	HI, IN, LO, N.C.
Beeper	HI, LO, N.C. (when beeper mode is fail), or IN (when beeper mode is pass)

Down and Up Arrow Keys  

These keys serve three functions:

- During a measurement, these keys change the Auto/Hold Range mode from Auto to Hold (when in the Auto Range mode) and change the measurement range.
- When you enter a value for the value setup keys, these keys increase or decrease the setting value.
- When you select an item for the selection keys, these keys are user to activate the item (the selected item blinks).

0, . . . , 9, .(point), –(minus) Keys  . . .   

These keys are used to enter numeric data into the HP 4339A. Pressing  terminates numeric data input.

Shift Key 

The blue Shift key activates the secondary function printed above the keys.

The Shift key toggle is cleared by a single execution of a shifted function or by pressing the Shift key again. The **Shift** annunciator is displayed when the Shift key is toggled to active mode.

Exponential Key 

The Exponential key is used to enter an exponential value.

Back Space Key 

The Back Space key deletes a single preceding character of an input value.

Enter Key 

The Enter key terminates data input or setting, and returns to measurement mode.

Minimum Key  

The Minimum key enters the minimum value during a parameter setting operation.

Maximum Key  

The Maximum key enters the maximum value during a parameter setting operation.

3 Function Reference



Open Key

The Open key executes an OPEN correction measurement to obtain the OPEN correction data. The HP 4339A uses this data to cancel the stray capacitance of the cable for the contact check function and the residual resistance of the test fixture. The data is stored in non-volatile memory (EEPROM). See “Performing OPEN Correction” in Chapter 1 for more information.

At reset, the correction data is cleared.



Calibration Key

The Calibration key executes the calibration function. Calibration cancels the internal offset error and the proportional error of the HP 4339A due to environmental temperature changes. The calibration data are stored in backup memory. Refer to “Performing Calibration” in Chapter 1 for more information.

At reset   , the calibration data is cleared.



Contact Check Key

The Contact Check key toggles the contact check function ON and OFF. This function monitors whether the DUT is properly connected to the test fixture or test leads.

- N.C. (No-Contact) will be displayed on the LCD display.
- The measurement status of the HP-IB output data is set to 2 (No-Contact). Refer to “Address Key   ” for the HP-IB output data.
- The /NO CONTACT pin of the handler interface is asserted. Refer to “Handler Interface” for the pin assignment of the handler interface.
- The measurement is still performed, and the measurement result is outputted to the HP-IB interface and the handler interface.

The decision limit value of the contact is obtained during an OPEN correction. When the OPEN correction is performed, unconnected capacitance is measured and stored. The HP 4339A compares this value with the DUT’s capacitance.



The **Cont Chk On** annunciator is displayed when the contact check function is ON. The default setting is OFF.

Display Mode Key   Disp Mode

The Display Mode key selects the display mode from the following choices:

- Measurement Display** displays the measurement result. (default)
(When the contact check function is ON and the contact check has failed, N.C. (no-contact) will be displayed instead of the measurement data.)
- Comparison Display** (When comparator function is ON,) Displays the result of the comparison as HI (greater than upper limit), IN (Passed), and LOW (less than lower limit), or N.C. (contact check failed).
(When comparator function is OFF,) Always displays OFF.
- Limit table Display** Displays the upper and lower limits of the comparator function.
- Display Off** Turns the display OFF (Only annunciators are displayed).
(Used, for example, in HP-IB remote mode.)

Key Lock Key   Key Lock

The key lock key locks out all front panel key inputs except for this key. To cancel the key lock condition, press   again. The key lock state is indicated by the annunciator.

3-Function Reference

Reset Key

The Reset key resets all instrument settings and correction data to the default values.

The HP 4339A can also be reset by sending HP-IB commands :SYST:PRES and *RST, with the same results, except in a couple of cases. The following table lists the difference among the results of pressing the Reset key and sending the :SYST:PRES and *RST command, and also lists where the settings are stored in.

Data stored in back-up memory is held for about 72 hours after powering OFF. The items saved by the Save key or recalled by the recall key are the same as those stored in the back-up memory. Data stored in EEPROM is not affected by powering OFF.



Table 3-3. Reset Settings

Item	Reset key	SYST:PRES ¹	*RST ¹	Stored in
Test voltage output state	OFF	←	←	None
Test voltage level	0 V	←	←	Back-up memory
Current limit	0.5 mA	←	←	Back-up memory
Measurement parameter	R	←	←	Back-up memory
Thickness of DUT	2 mm	←	←	Back-up memory
Electrode size (DI)	50 mm	←	←	Back-up memory
Electrode size (AREA)	19.635 mm ²	←	←	Back-up memory
Electrode size (PERIMETER)	18.850 cm	←	←	Back-up memory
Electrode size (GAP)	1.000 cm	←	←	Back-up memory
Effective area coefficient (B)	0	←	←	Back-up memory
Deviation measurement	OFF	←	←	Back-up memory
Deviation reference value	Cleared	←	←	Back-up memory
Measurement range mode	Auto	←	←	Back-up memory
Measurement range	(Auto)	←	←	Back-up memory
Measurement time mode	Medium	←	←	Back-up memory
Averaging rate	1	←	←	Back-up memory
Trigger mode	Internal	←	←	Back-up memory
Trigger delay time	0 s	←	←	Back-up memory
Contact Check ON/OFF state	OFF	←	←	Back-up memory
Comparator ON/OFF state	OFF	←	←	Back-up memory
Comparator limits	Cleared	←	←	Back-up memory
Program sequence running	Aborted	←	←	None
Program sequence	OFF	←	←	Back-up memory
Change time	10 s	←	←	Back-up memory
Interval time	1 s	←	←	Back-up memory
Memory size	500	←	←	Back-up memory
Display mode	Measured Display	←	←	Back-up memory
Correction ON/OFF state	ON	←	OFF	None
Correction data	Cleared	←	←	EEPROM
Offset-Error Canceling	OFF	←	←	EEPROM

¹ "←" indicates the value is the same as what is indicated to the left.

Table 3-3. Reset Settings (continued)

Item	Reset key	SYST:PRES ¹	*RST ¹	Stored in
Beep ON/OFF state	ON	←	←	EEPROM
Beep mode	FAIL mode	←	←	EEPROM
Data transfer format	ASCII	←	←	EEPROM
Power line frequency	No effect	←	←	EEPROM
HP-IB Address	No effect	←	←	EEPROM
Key lock	N/A	No effect	OFF	None
:INT:CONT	ON	←	OFF	None

Configuration Key  

The Configuration key allows you to set the offset-error canceling, the beep mode, and the power line frequency, and to run the self-test.

OFST Sets the offset-error canceling ON or OFF. This function automatically cancels the offset error due to the temperature change every 30 seconds, when the measurement range is 100 pA or 1 nA, and the measurement time mode is the Long mode. When this function is set to OFF, the offset error may increase a little. The default setting is OFF.

The following figure shows the measurement timing diagram when the offset-error canceling is set to ON.

3 Function Reference

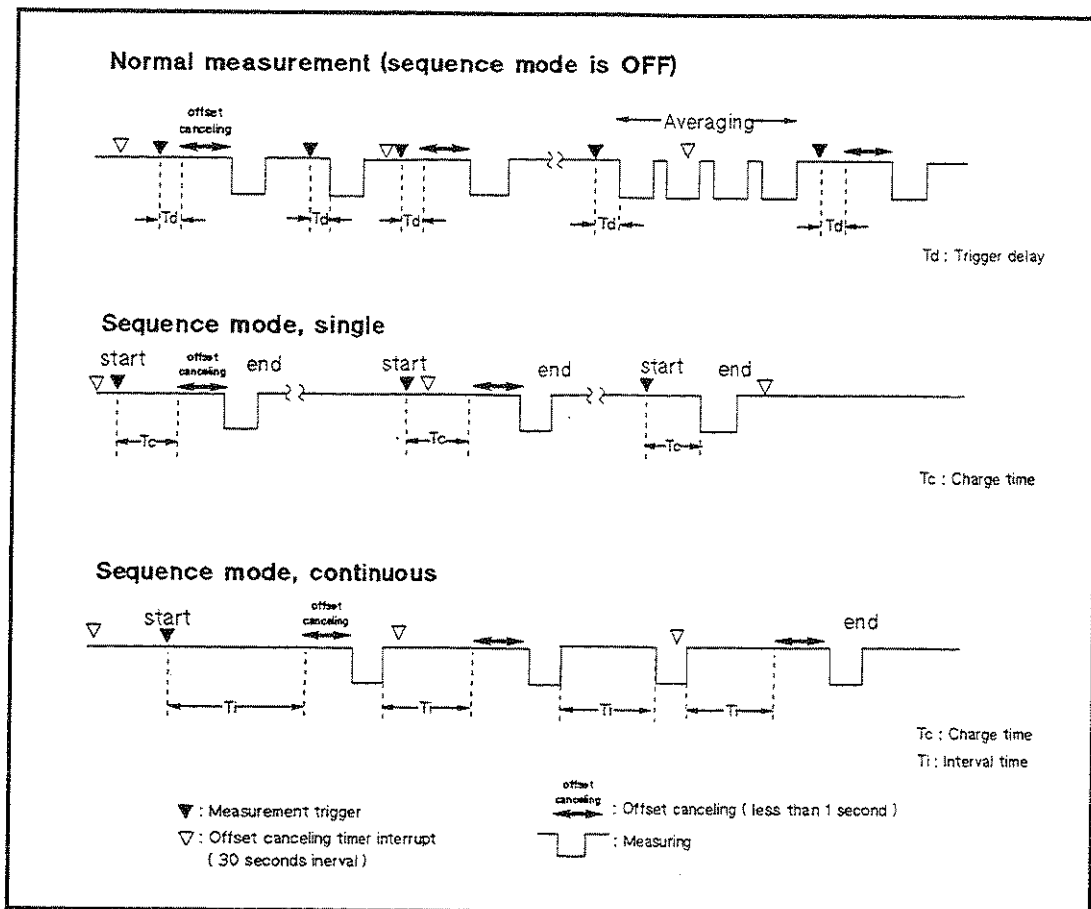

Figure 3-3. Offset-Error Canceling Timing Chart

- BEEP** Comparison results output to the beeper are classified into following modes:
- OFF** Does not emit a beep (no output to beeper).
 - PASS** Emits a beep when the comparison result is IN.
 - FAIL** Emits a beep when the comparison result is HI, LO or N.C.. (default)

Note In the OFF mode, the HP 4339A does *not* emit a beep when a system error or operation error occurs.



- LINE** Available power LINE frequency selections are 50 Hz and 60 Hz.
- MORE** Displays the internal test menu.
 - **SVC** — There are five service functions.
 - KEY** Tests the front-panel keys.
 - HNDL** Tests the handler output signal.
 - CSUM** Runs the ROM check sum program.
 - RAM** Tests RAM (the read-write test). After the test, the HP 4339A resets the instrument's settings.

EEPROM Tests EEPROM. The data stored in EEPROM is not affected when no error is detected. If errors are detected, the HP 4339A clears the data and restores the default data.

- **TEST (Self-test)** – The self-test tests the HP 4339A’s basic performance and displays the results as the sum of error codes of each existing error.

The HP 4339A also executes its self-test when it is turned ON (power-on test). The settings of the HP 4339A are not affected by the self-test, except when errors occur.

Item	Result	Error Code
1. Beeper	beep once	-
2. Display	display all digits and segments	-
3. RAM	display error message if an error occurs ¹	1
4. EPROM	display error message if an error occurs ¹	2
5. Calibration data (EEPROM)	display error message if an error occurs ¹	4
6. User's data (EEPROM)	display error message if an error occurs ²	8
7. AD converter	display error message if an error occurs ¹	16
8. Backup RAM	display error message if an error occurs ²	32

1 During the power-on test, the HP 4339A stops operation if an error occurs.

2 During the power-on test, the HP 4339A uses default values and continues the test.

EXIT Returns to measurement.

Rear Panel

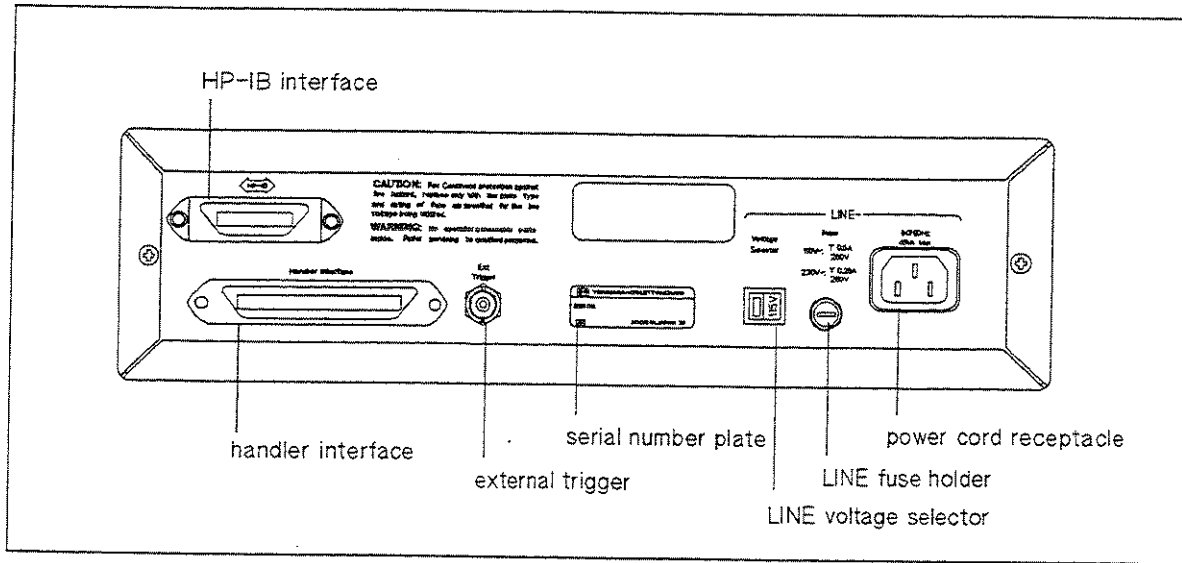

Figure 3-4. Rear Panel

External Trigger

The Ext (External) Trigger terminal is used to trigger the HP 4339A by inputting a positive-going TTL pulse, when the HP 4339A is set to external trigger mode. Figure 3-5 shows the specifications required for the TTL pulse.

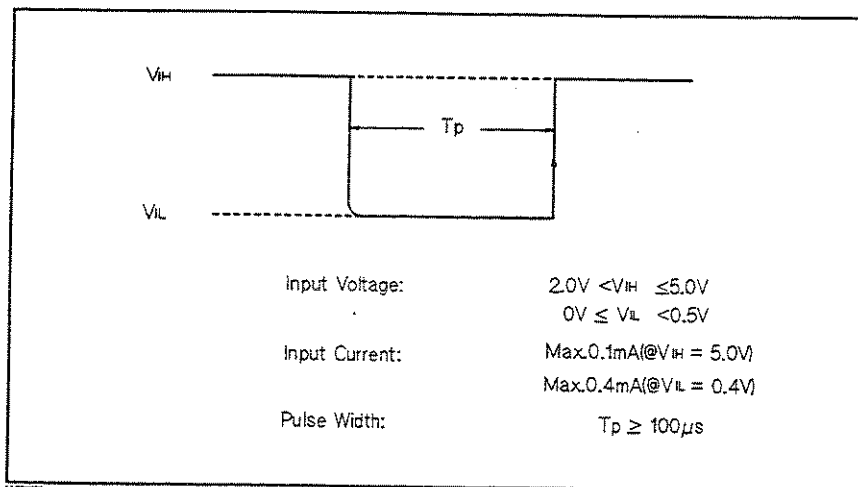

Figure 3-5. Required External Trigger Pulse Specification

Handler Interface

Handler interface is used to synchronize timing with an external handler.

Before using the handler interface, you must connect pull-up resistors to enable the output signals and set the dip switch to select the voltage level to match the input signals. Refer to Appendix B for these procedures.

Specifications

- **Output signal** : Negative TRUE, open collector, opto-isolated

Decision Output:

Primary parameter Comparator High, In, Low
 Secondary parameter Comparator High, In, Low
 DUT and test electrode's contact failed.

Index: Analog measurement complete

Measurement complete: Full measurement complete

Alarm: Notification that a momentary power failure was detected or the error occurs.

- **Input Signal** : Opto-isolated

Keylock: Front panel keyboard lockout

External Trigger: Pulse width $\geq 1 \mu s$

3 Function Reference

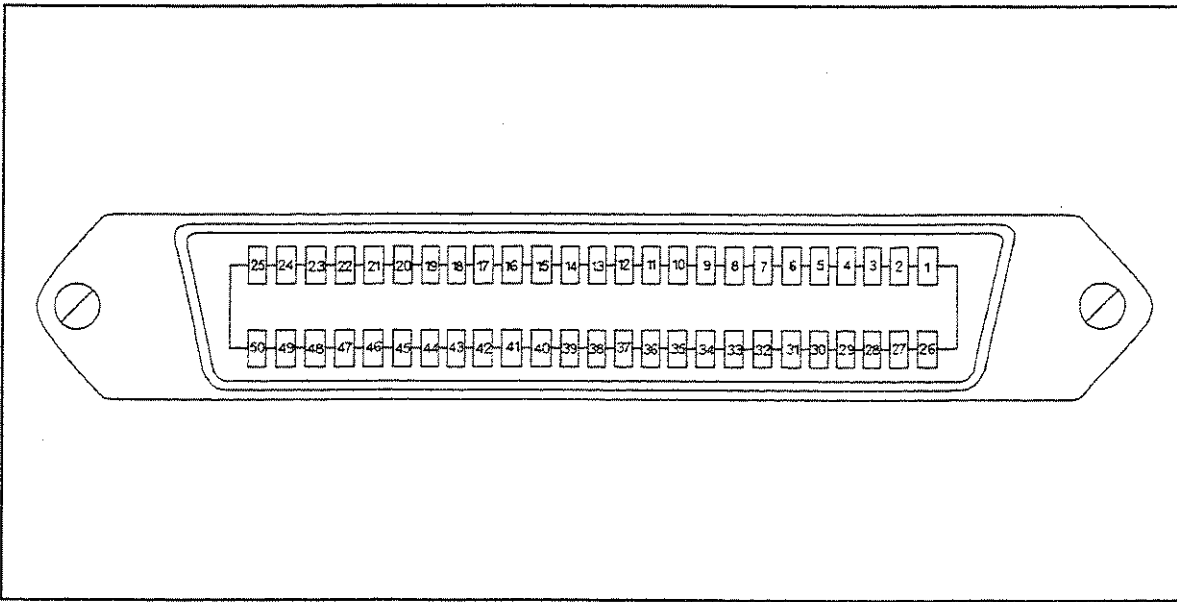

L5003006

Figure 3-6. Pin Assignment for Handler Interface Connector

Table 3-4. Contact Assignment for Comparator Function

Pin No.	Signal Name ¹	Description
1 2	EXT DCV1 EXT DCV1	External DC Voltage 1: DC voltage supply pins for DC isolated open collector outputs (/HI, /IN/, /LO/, /NO CONTACT). Maximum voltage is +24 V, minimum +5
17	/HV OFF	Voltage Source OFF: When this line is asserted, output of the voltage source is disabled.
18	/KEY LOCK	Key Lock: When this line is asserted, all of the HP 4339A's front panel key functions are disabled.
19	/EXT TRIG	External Trigger: HP 4339A is triggered on the rising edge of a pulse applied to this pin when the trigger mode is set to the External. ²
20 21	EXT DCV2 EXT DCV2	External DC voltage 2: DC voltage supply pins for DC Isolated inputs (/EXT TRIG, /KEY LOCK, /HV OFF) and DC Isolated outputs (/INDEX, /EOM, /NOT READY, /ALARM). Maximum voltage is +15 V, minimum +5 V
24 25	+5 V +5 V	Internal voltage supply (max. output 0.1 A): Exceeding 0.1 A will cause the internal voltage output and the output signals to go to zero.
26 27	COM1 COM1	Common for EXT DCV1
28	/HI	This signal is asserted, when the comparison result is High. ³
29	/IN	This signal is asserted, when the comparison result is In. ³
30	/LO	This signal is asserted, when the comparison result is Low. ³
37	/NO CONTACT	This signal is asserted, when the contact check failed. ³
41	/NOT READY	Not ready: This signal is asserted when the current flowing through the DUT exceeds the current limit.
42	/ALARM	Alarm: This signal is asserted when a power failure occurs or the error (E11, E12, E13, E14, E15, E20 or E-313) occurs.
43	/INDEX	Index: This signal is asserted when an analog measurement is complete and the HP 4339A is ready for the next DUT to be connected to the UNKNOWN terminals. The measurement data, however, is not valid until /EOM is asserted.
44	/EOM	End of Measurement: This signal is asserted when the measurement data and comparison results are valid.
45 46	COM2 COM2	Common for EXT DCV2
49 50	GND GND	Ground tied to chassis.

1 The / (slash) means that the signal is asserted when low.

2 If an error occurs and the HP 4339A stops operation, the HP 4339A will not trigger a measurement after receiving the /EXT TRIG signal.

3 If an error occurs and the HP 4339A stops operation, these lines maintain the condition just before the error occurred.

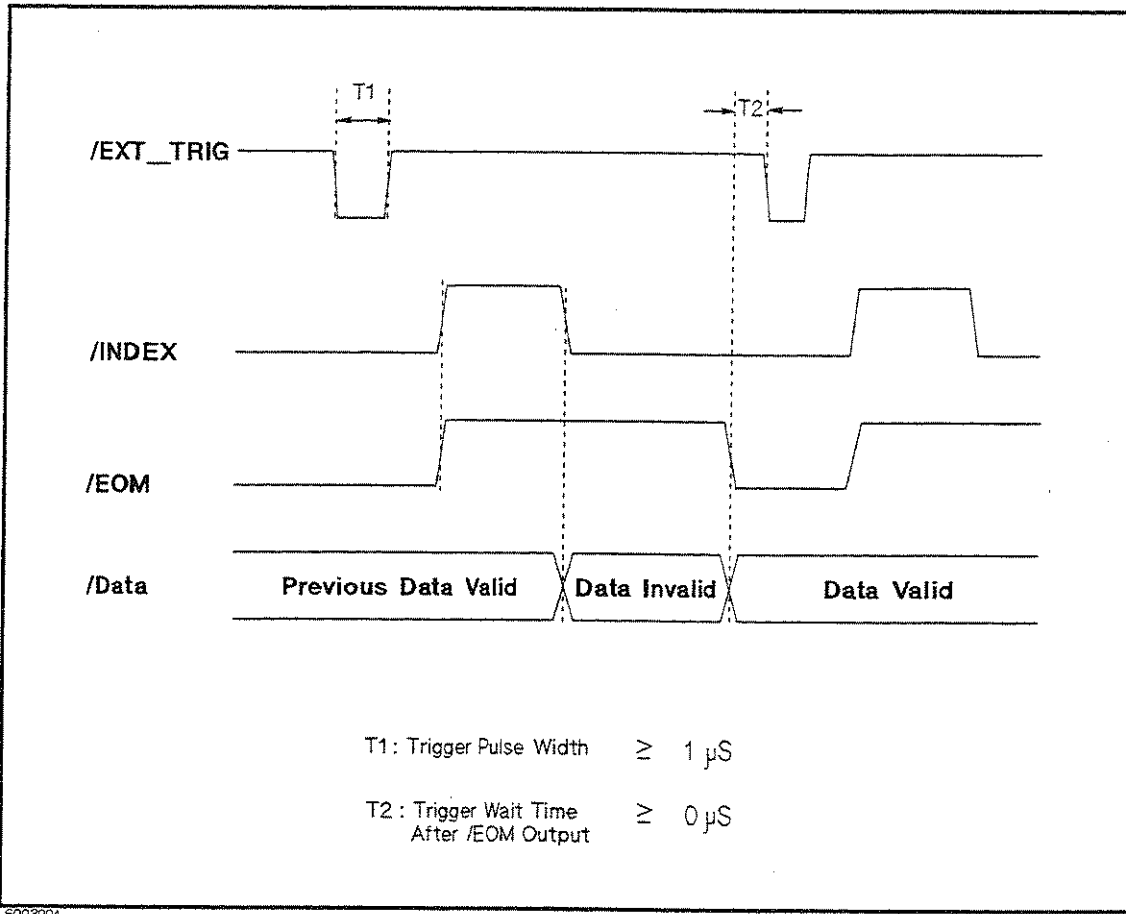

Figure 3-7. Timing Diagram

Note



This timing diagram is also applied when the contact check fails, because the measurement is performed and the measurement result is output, even if the contact check fails.

3 Function Reference

Electrical Characteristics

Output Signals. Each DC output is isolated using open collector output opto-isolators. The output voltage of each line is enabled by putting pull-up resistors on the main board, and by connecting the pull-up resistors to an externally applied DC voltage.

The electrical circuits of the DC isolated outputs are divided into two groups to be able to separate power supplies (refer to Table 3-5).

A simplified diagrams of the output signals is shown in Figure 3-8 for comparison signals and Figure 3-9 for control signals.

Table 3-5. Handler Output Electrical Characteristics

Output Signals	Voltage Output Rating		Maximum Current	External Voltage/Circuit Common
	Low	High		
Comparison Signals /HI /IN /LO /NO CONTACT	≤ 0.5 V	5 to 24 V	6 mA	EXT DCV1 COM1
Control Signals /ALARM /INDEX /EOM /NOT READY	≤ 0.5 V	5 to 15 V	6 mA	EXT DCV2 COM2

Note



The pull-up resistors in Figure 3-8 and Figure 3-9 are *not* mounted when HP 4339A is shipped from the factory. Before using the handler interface, mount the pull-up resistors.

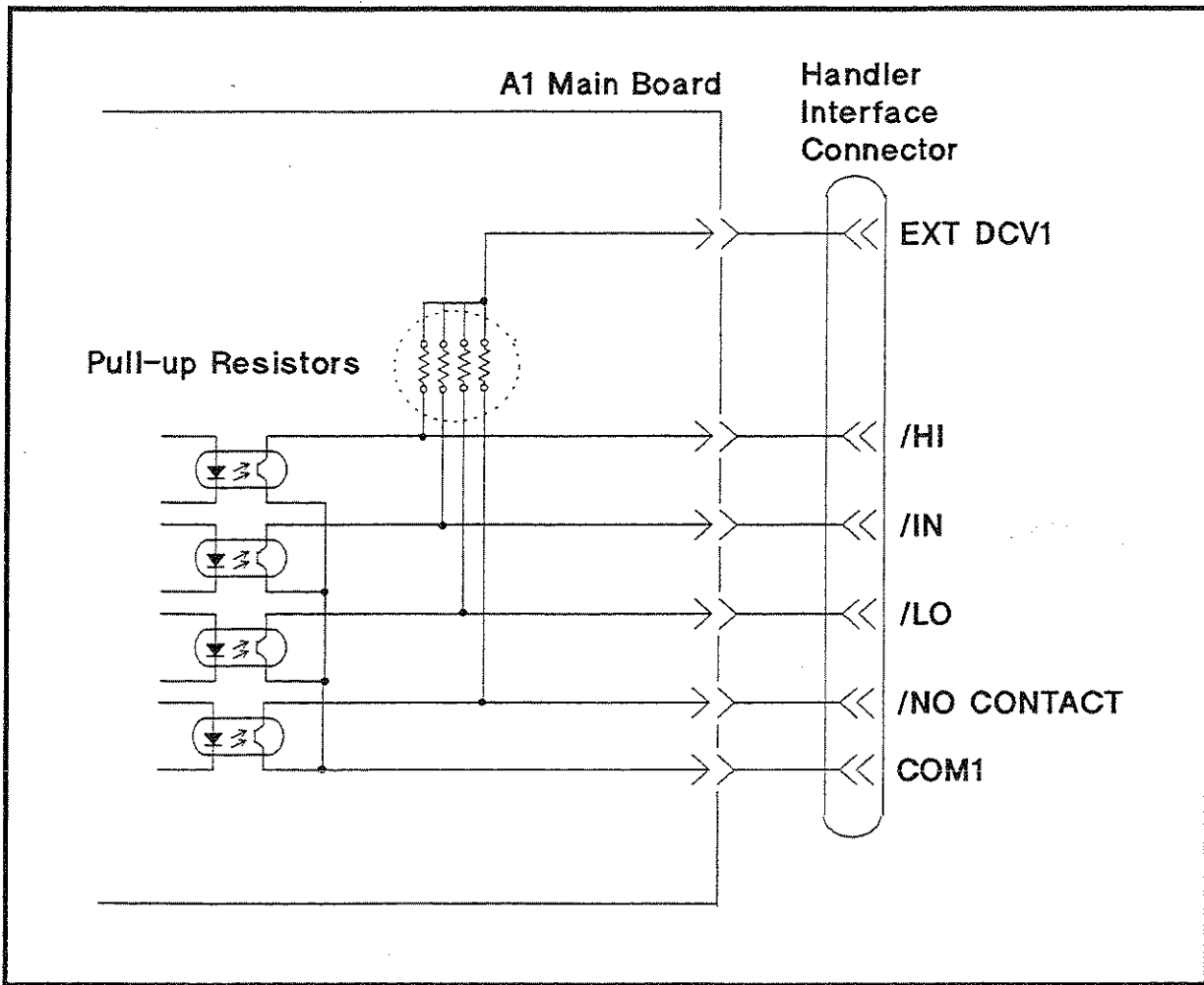

3 Function Reference

L500B001

Figure 3-8. Handler Interface Comparison Output Signals Diagram

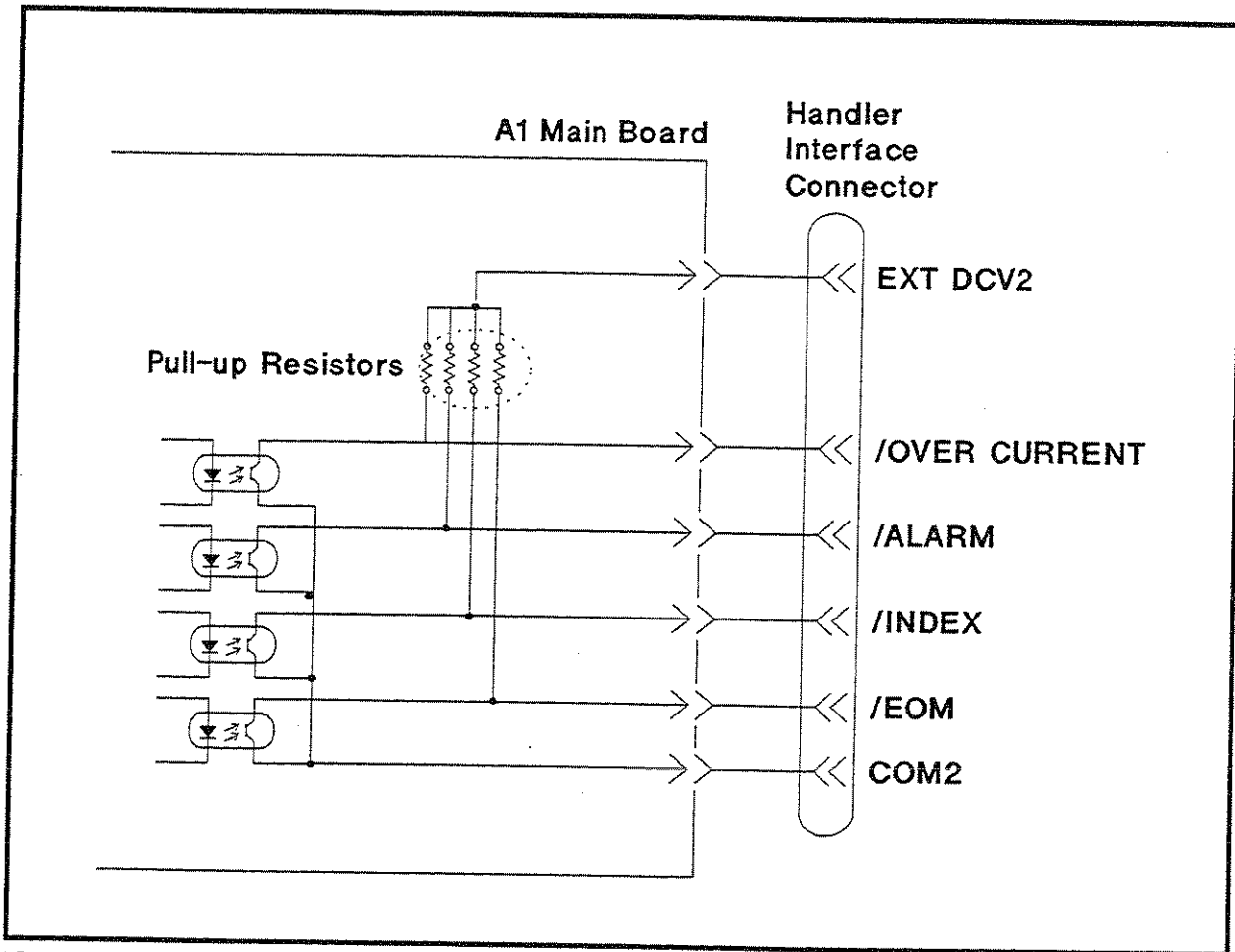

L500B003

Figure 3-9. Handler Interface Control Output Signals Diagram

Input Signals. The DC isolated input signals are connected to the cathodes of the LEDs in the opto-isolators. The anodes of the LED's are powered by an external voltage source (EXT DCV2).

The OFF state voltage (high level) of the DC isolated input signals depends on the pull-up voltage powered by an external; voltage source (EXT DCV2). (The input current is restricted by using a switch on the main board.)

The electrical characteristics of the input signals are listed in Table 3-6. A diagram for the input signals is shown in Figure 3-10.

Table 3-6. Handler Input Electrical Characteristics

Signal	Input Voltage		Input Current (Low) Pull-up Voltage			Circuit Common
	Low	High	5 V	12 V	15 V	
/EXT TRIG	< 1 V	5 to 15 V	11.1 mA	10.5 mA	13.5 mA	COM2
/KEY LOCK	< 1 V	5 to 15 V	5.2 mA	14.5 mA	18.5 mA	COM2
/HV OFF	< 1 V	5 to 15 V	11.1 mA	10.5 mA	13.5 mA	COM2

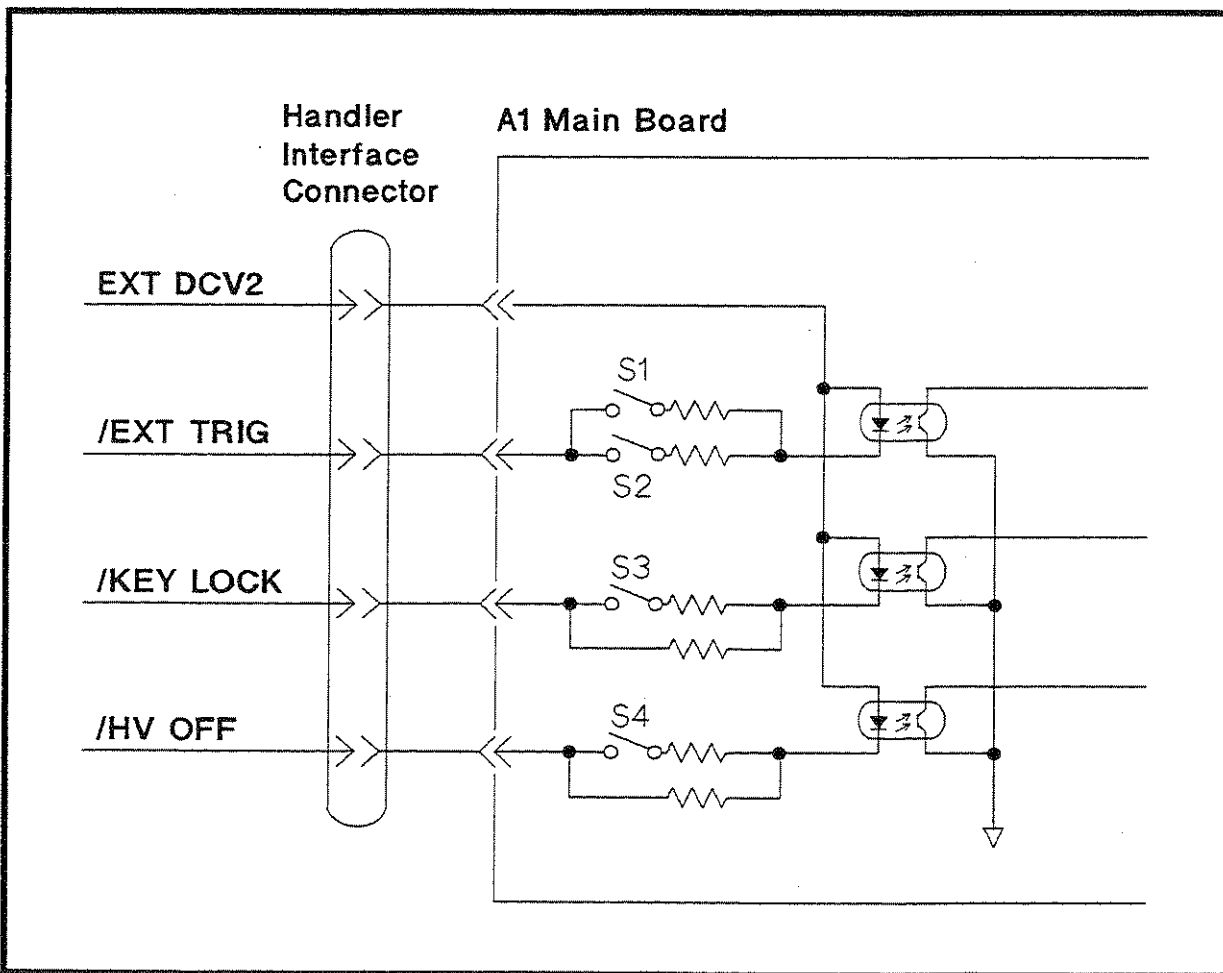

L5008002

Figure 3-10. Handler Interface Input Signal Diagram

3 Function Reference

HP-IB Interface

The HP-IB Interface is used for remote control of the HP 4339A using the Hewlett-Packard Interface Bus (HP-IB).

HP-IB is a standard for interfacing instruments to computers, and supports for IEEE 488.1, IEC-625, IEEE 488.2, and JIS-C1901. HP-IB allows instruments to be controlled by an external computer which sends commands or instructions to and receives data from the instrument.

With the HP-IB system, many different types of devices including instruments, computers, plotters and printers can be connected in parallel. When configuring an HP-IB system, the following restrictions must be adhered to:

- The length of cable between one device and another must be less than or equal to four meters. The total length of cable in one bus system must be less than or equal to two meters times the number of devices connected on the bus (the HP-IB controller counts as one device) and must not exceed 20 meters.
- A maximum of 15 devices can be connected on one bus system.
- There are no restrictions on how the cables are connected together. However, it is recommended that no more than four piggyback connectors be stacked together on any one device, or else the resulting structure could exert enough force on the connector mounting to damage it.

Every HP-IB device has its own unique identification address. The available HP-IB addresses are integer numbers from 0 to 30. Every device on an HP-IB bus must have a unique address.

Table 3-7 lists the HP 4339A's HP-IB capability and functions. These functions provide the means for an instrument to receive, process, and transmit commands, data, and status over the HP-IB bus.

Table 3-7. HP-IB Interface Capability

Code	Function
SH1	Complete source handshake capability
AH1	Complete acceptor handshake capability
T5	Basic talker; serial poll; Unaddressed if MLA; Talk-Only
L4	Basic listener; Unaddressed if MTA; no Listen Only
SR1	Service request capability
RL1	Remote/Local capability
DC1	Device clear capability
DT1	Device trigger capability
C0	No controller capability
E1	Drivers are open-collector

LINE Fuse Holder

The HP 4339A's line fuse is selected depending on the LINE Voltage selection. Refer to Table 3-8.

LINE Voltage Selector

The Line Voltage Selector is used to match the HP 4339A to the power line voltage being used. The line voltage selections are as follows:

Table 3-8. Power Voltage Selector Setting

Voltage Selector	Line Voltage	Required Fuse
115 V	100 V / 120 V	T 0.5 A 250 V (HP part number 2110-0202)
230 V	220 V / 240 V	T 0.25 A 250 V (HP part number 2110-0201)

Power Cord Receptacle

The Power Cord Receptacle is used to plug in the power cord.

Power Cord

To protect operating personnel, the National Electrical Manufacturer's Association (NEMA) recommends that the instrument panel and cabinet be grounded. The HP 4339A is equipped with a three-conductor power cord that, when plugged into the appropriate ac power receptacle, grounds the instrument. The offset pin on the power cord is the safety ground.

To preserve the protection feature when operating the instrument from a two prong outlet, use a three-prong to two-prong adapter (HP Part Number 1251-8196) and connect the green pigtail on the adapter to the power-line ground.

Caution The power plug must be plugged into an outlet that provides a protective earth ground connection. Do *not* use an extension cord or power cord that does not have a protective ground.



3-Function Reference

Figure 3-11 shows the available power cords used in various countries. Also shown is the standard power cord furnished with the instrument. HP part numbers, applicable standards for power plugs, electrical characteristics, and the countries using each type of power cord are listed in Figure 3-11. For assistance in selecting the correct power cord, contact the nearest Hewlett-Packard sales office.

<p>OPTION 900 United Kingdom</p>  <p>Plug: BS 1363A, 250V Cable: HP 8120-1351</p>	<p>OPTION 901 Australia/New Zealand</p>  <p>Plug: NZSS 198/AS C112, 250V Cable: HP 8120-1369</p>
<p>OPTION 902 European Continent</p>  <p>Plug: CEE-VII, 250V Cable: HP 8120-1689</p>	<p>OPTION 903 U.S./Canada</p>  <p>Plug: NEMA 5-15P, 125V, 15A Cable: HP 8120-1378</p>
<p>OPTION 904 U.S./Canada</p>  <p>Plug: NEMA 6-15P, 250V, 15A Cable: HP 8120-0698</p>	<p>OPTION 905* Any country</p>  <p>Plug: CEE 22-VI, 250V Cable: HP 8120-1396</p>
<p>OPTION 906 Switzerland</p>  <p>Plug: SEV 1011.1959-24507 Type 12, 250V Cable: HP 8120-2104</p>	<p>OPTION 912 Denmark</p>  <p>Plug: DHCR 107, 220V Cable: HP 8120-2956</p>
<p>OPTION 917 India/Republic of S.Africa</p>  <p>Plug: SABS 164, 250V Cable: HP 8120-4211</p>	<p>OPTION 918 Japan</p>  <p>Plug: JIS C 8303, 125V, 15A Cable: HP 8120-4753</p>
<p>NOTE: Each option number includes a 'family' of cords and connectors of various materials and plug body configurations (straight, 90° etc.).</p> <p>* Plug option 905 is frequently used for interconnecting system components and peripherals.</p>	

Figure 3-11. Power Cord Available

Serial Number Plate

The serial number plate provides manufacturing information about the HP 4339A. For details, see "Serial Number" in Appendix A.

Theory of Operation

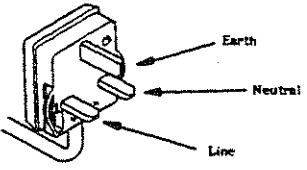
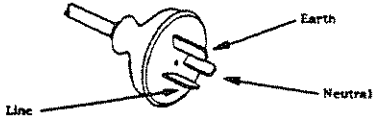
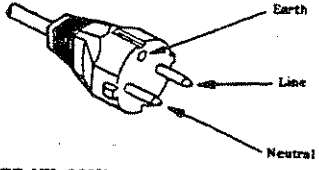
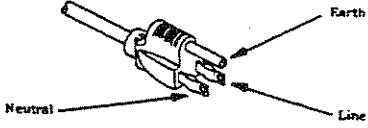
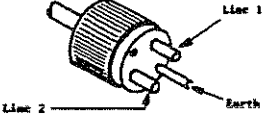
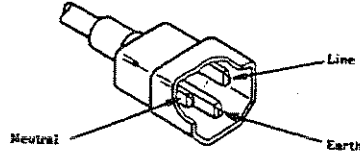
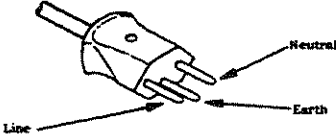
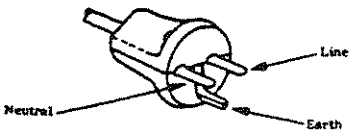
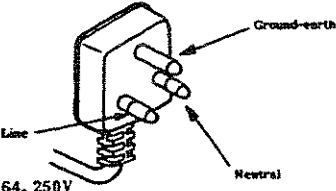
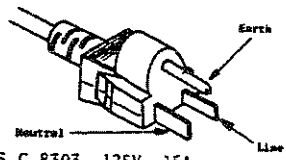
This section provides the HP 4339A's theory of operation.

In "Overall Measurement Theory" and "Overall Block Diagram", we will discuss the measurement theory with the ungrounded DUT measurement configuration. These descriptions can also be applied to the measurement of a grounded DUT, considering the test signal flow shown in Figure 3-14 (b).

Overall Measurement Theory

The HP 4339A measures the Device Under Test (DUT) resistance in the following manner.

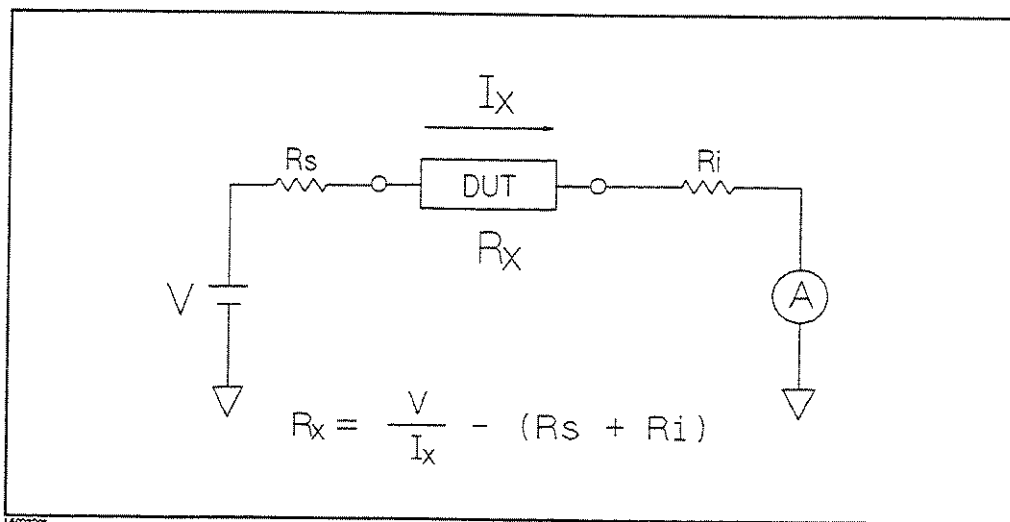

Figure 3-12. Simplified Model of Impedance Measurement

Figure 3-12 shows a simplified model of the HP 4339A measuring a DUT. In the Figure 3-12, the DUT is connected in series with a test voltage source, V , and an ammeter, A . R_s is the HP 4339A's source resistance ($R_s = 1k\Omega$) and R_i is the input resistance ($R_i = 1k\Omega$).

In the resistance measurement mode (the measurement parameter is R), the HP 4339A displays the "derived" DUT resistance, R_x . In other words, if the ammeter measures I_x when the source voltage is V , the HP 4339A displays the DUT resistance R_x , calculated using the following equation:

$$R_x = \frac{V}{I_x} - (R_s + R_i)$$

In the current measurement mode (the measurement parameter is I), the HP 4339A measures the actual current value, I_x , which flows through the DUT, and displays the value for the measurement result. For example, if R_x is $100k\Omega$, and V is $1V$, the measurement result will be $9.8\mu A$ ($\frac{1V}{100k+2k}$). If you measure a DUT whose resistance value is lower, the HP 4339A's source resistance, R_s , and input resistance, R_i , affect the measurement current value, I_x , more.

Overall Block Diagram

Figure 3-13 shows the overall block diagram of the HP 4339A.

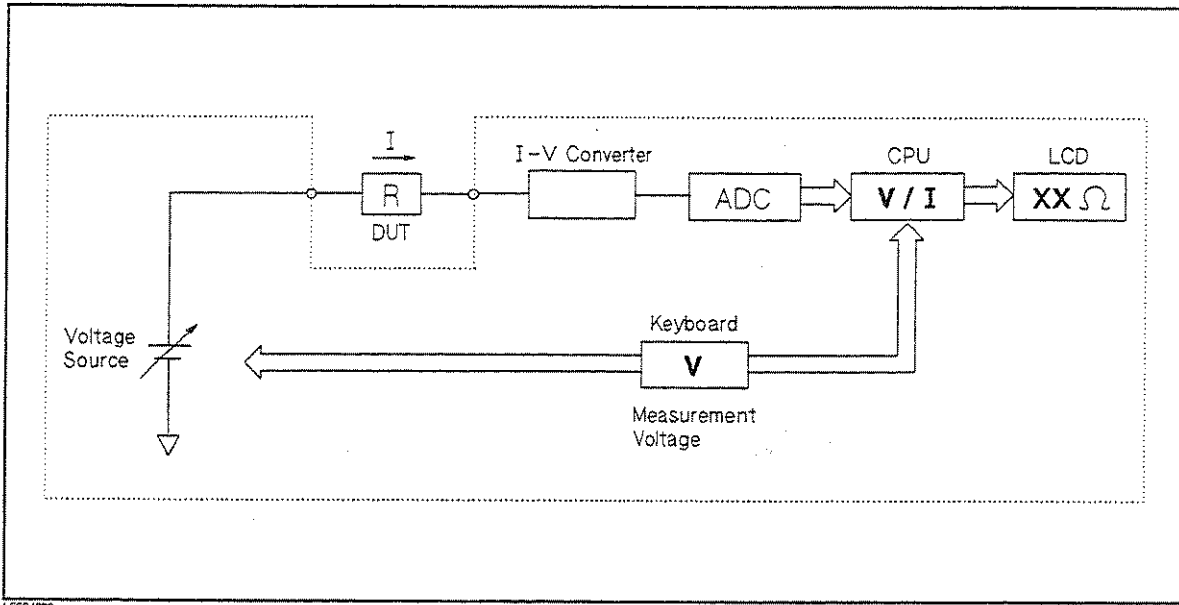

Figure 3-13. HP 4339A Overall Block Diagram

The voltage source applies a dc voltage which is set by the keyboard or by an HP-IB command. The I-V converter, which is directly connected to the input, converts the current into a voltage ramp, of which the slope is proportional to the input current. The CPU calculates the current from the voltage ramp slope, then calculates the DUT's resistance by dividing the source voltage by the current.

3-Function Reference

Grounded and Ungrounded DUT Measurement Configuration

The HP 4339A has the capability to measure both grounded and ungrounded DUTs.

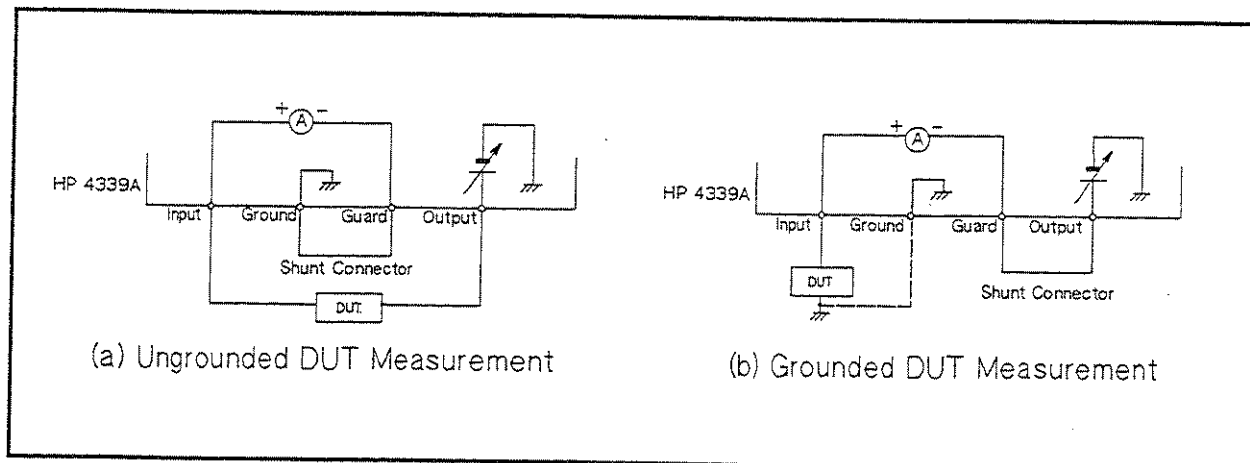

Figure 3-14. Ungrounded and Grounded DUT Measurement

In Figure 3-14 (a), the Ground and the Guard terminal are connected by a shut connector. The Input terminal is connected to one side of the DUT, while the other side of the DUT is connected to the Output terminal. In this configuration, the Output terminal supplies the test voltage to the DUT, and the test current through the DUT is input to the HP 4339A through the Input terminal, which is connected to the ammeter circuit.

In Figure 3-14 (b), the Guard and Output terminals are connected by the shut connector, and the Input terminal is connected to the grounded DUT. The Output terminal supplies the test voltage to the DUT (through the ammeter circuit).

When you measure the grounded DUT, the Ground terminal may be left open, however, for more precise measurement, the Ground terminal and the DUT's ground should be connected to each other as a common ground.

Note



In the HP 4339A's ammeter measures the test current as a positive value when current flows from the Input terminal to the Guard terminal. So, an ungrounded DUT measurement results in a positive current value, and a grounded DUT measurement results in a negative current value. (Resistance, R , is always a positive value.)

Remote Operation

Introduction

This chapter provides step-by-step instructions for controlling the HP 4339A using HP-IB remote mode. The examples in this manual use the HP 9000 series 200 or 300 BASIC language. This chapter covers the following:

- Getting started
- Setting up the HP 4339A
- Triggering a measurement
- Retrieving measurement data
- Other features
- If you have a problem

Refer to Chapter 5 for the description of each HP-IB command.

Note



In this chapter, all commands are spelled in abbreviated (short) form. Refer to “Command Abbreviations” in Chapter 5 for more information.

Note



This chapter is not intended to teach BASIC programming language or the Standard Commands for Programmable Instruments (SCPI) programming, or to discuss HP-IB theory; refer to the following documents which are better suited for these tasks.

For more information concerning BASIC, refer to the manual set for the BASIC version being used:

BASIC Programming Techniques
BASIC Language Reference

For more information concerning SCPI, refer to the following:

Beginner's Guide to SCPI

For more information concerning HP-IB operation, refer to the following:

BASIC Interfacing Techniques
Tutorial Description of the Hewlett-Packard Interface Bus
Condensed Description of the Hewlett-Packard Interface Bus

Getting Started

This section will teach you the basics of operating the HP 4339A in HP-IB remote mode (from now on referred to as remote). This includes reading the HP-IB address, sending commands to the HP 4339A, and retrieving data from the HP 4339A.

Input/Output Statements

The statements used to operate the HP 4339A in remote depend on the computer and the programming language being used. In particular, you need to know the statements the language uses to input and output information. The input statements for the HP 9000 series 200 or 300 BASIC language are:



ENTER or TRANSFER

The output statement is:

OUTPUT

Read your computer manuals to find out which statements you need to use.

Reading the HP-IB Address

Before you can operate the HP 4339A in remote, you need to know its HP-IB address (factory setting=17). To check the address, press  . A typical display is:



The displayed response is the device address. When sending a remote command, you append this address to the HP-IB interface's select code (normally 7). For example, if the select code is 7 and the device address is 17, the appended combination is 717.

Every device on the HP-IB bus must have a unique address. You can assign new HP-IB addresses.



Sending a Remote Command

To send a remote command to the HP 4339A, combine the computer's output statement with the HP-IB select code, the device address, and finally the HP 4339A command. For example, to reset the HP 4339A, send:

OUTPUT 717;"*RST"

Notice that the display's **Adrsd** and **Rmt** annunciators are ON. This means the HP 4339A is in the remote mode and has been addressed to listen (receive commands).

Returning to Local Mode

When you press a key on the HP 4339A's keyboard while operating in remote, the HP 4339A does not respond. This is because in remote (as indicated by the display's **Rmt** annunciator) the HP 4339A ignores all front panel inputs except the  key. To return the HP 4339A to the Local mode, press the .

Query Commands

There are several commands in the alphabetic command directory that end with a question mark. These commands are called query commands because each returns a response to a particular question.

In addition to the queries described above, you can create others by appending a question mark to most commands.

Getting Data from the HP 4339A

The HP 4339A can output readings and responses to query commands. As an example, have the HP 4339A generate a response to a query command by sending:

```
OUTPUT 717; "*IDN?"
```

When you send a query from remote, the HP 4339A does not display the response as it would if you executed the command from its front panel. Instead, the HP 4339A sends the response to its output buffer. The output buffer is a register that holds a query response or data for a single measurement until it is read by the computer or replaced by new information. Use the computer's input statement to get the response from the output buffer. For example, the following program reads the response (HP 4339A) and prints it.

```
10 ENTER 717;A$
20 PRINT A$
30 END
```

To Control the HP 4339A from an External Computer

Most measurements can be modeled by the following simple four step sequence:

1. Set up the instrument.

Typically, you begin the setup step by sending the *RST command to set the instrument to its default settings. Next, if you need values different from the default settings, change the settings one by one as required.

2. Trigger the measurement.

The trigger may be generated automatically by steps taken in your setup commands, or you may send an explicit trigger command. To select the trigger source, send the :TRIG:SOUR command with the trigger source parameter. When you select BUS as the trigger source, sending *TRG triggers a measurement and retrieves the measurement data.

3. Retrieving the data.

4. Turn OFF the test voltage and end the measurement.

Figure 4-1 shows a simple resistance measurement program.

```

:
! Step 1                               Resetting
OUTPUT 717;"*RST"
OUTPUT 717;" :INIT:CONT ON"           Initializing trigger system
OUTPUT 717;" :FUNC 'RES'"            Resistance measurement
OUTPUT 717;" :SOUR:VOLT 10"          Test voltage: 10 V
OUTPUT 717;" :OUTP ON"               Applying test voltage
OUTPUT 717;" :TRIG:SOUR BUS"         Trigger source: Bus
! Step 2                               Triggering
OUTPUT 717;"*TRG"
! Step 3                               Retrieving the data
ENTER 717;R_value
! Step 4                               Turning OFF test voltage
OUTPUT 717;" :OUTP OFF"
:

```

Figure 4-1. Simple Program Example

The following sections describes how to perform specific tasks.

To Set Up the HP 4339A

To Reset the HP 4339A

The following commands reset the HP 4339A:

- *RST
- :SYST:PRES

Note



The *RST command also initiates the trigger system also and places trigger sequence in the IDLE state. Refer to "Trigger System" in Chapter 5 for more information.

For example,

```
OUTPUT 717; "*RST"
```

To Set the Power LINE Frequency

The following command sets the power line frequency:

- SYST:LFR

For example, to set the LINE frequency to 50 Hz,

```
OUTPUT 717; ":SYST:LFR 50"
```

To Select the Measurement Parameter

The following commands select the measurement parameter:

- :SENS:FUNC
- :CALC:FORM

To select Resistance,

```
OUTPUT 717; ":SENS:FUNC 'RES'"
```

To select Volume Resistivity,

```
OUTPUT 717; ":SENS:FUNC 'RES'"
OUTPUT 717; ":CALC:FORM VRES"
```

To select Surface Resistivity,

```
OUTPUT 717; ":SENS:FUNC 'RES'"
OUTPUT 717; ":CALC:FORM SRES"
```

To select Current,

```
OUTPUT 717; ":SENS:FUNC 'CURR'"
```

To Set the Test Voltage

The following command sets the test voltage:

- :SOUR:VOLT

For example, to set 10 V as the test voltage,

```
OUTPUT 717; ":SOUR:VOLT 10"
```

To Apply the Test Voltage

The following commands apply the test voltage:

■ :OUTP

For example,

```
OUTPUT 717;":OUTP ON"
:
OUTPUT 717;":OUTP OFF"
```

Warning

Sending :OUTP command may cause the HP 4339A to output a dangerous voltage levels up to 1000 Vdc. Do *NOT* touch the UNKNOWN terminals or the electrodes of the accessory, when the V Output indicator is ON.

To Set the Current Limit

The following command sets the current limit value:

■ :SOUR:CURR:LIM

For example, to set 0.5 mA as the current limit value,

■ OUTPUT 717;":SOUR:CURR:LIM 0.5MA"

To Select Measurement Time Mode

The following command selects the measurement time mode:

■ :SENS:CURR:APER

To set the measurement time mode to SHORT:

```
OUTPUT 717;":SENS:CURR:APER 0.01"
```

To set the measurement time mode to MEDIUM:

```
OUTPUT 717;":SENS:CURR:APER 0.03"
```

To set the measurement time mode to LONG:

```
OUTPUT 717;":SENS:CURR:APER 0.39"
```

To Perform Calibration

The following command calibrates the HP 4339A:

■ :CAL?

For example,

```
:
OUTPUT 717;":CAL?"
ENTER 717;A
IF A<>0 THEN
  PRINT "Error:",A
  PAUSE
END IF
:
```

To Perform OPEN Correction

The following command performs an OPEN correction:

```
■ :SENS:CORR:COLL OFFS
```

For example,

```

:
DISP "Connect the test fixture without a DUT, then press 'Continue'."
PAUSE                                     Current measurement
OUTPUT 717;":SENS:FUNC 'CURR'"
OUTPUT 717;":SENS:CURR:APER 0.39"       Measurement time mode: Long
OUTPUT 717;":SOUR:VOLT 10"              Test voltage: 10 V
OUTPUT 717;":OUTP ON"                   Applying test voltage
REPEAT                                    Retrieving the data
  OUTPUT 717;":FETC?"
  ENTER 717;S,D                           Wait until current is within 0.5 pA
UNTIL ABS(D)<5.E-13
OUTPUT 717;":SENS:CORR:COLL OFFS"       Performing OPEN correction
OUTPUT 717;":*OPC?"                     Wait until OPEN correction ends
ENTER 717;A                               Turning OFF test voltage
OUTPUT 717;":OUTP OFF"
:

```

To Select the Measurement Range

The following commands select the measurement range:

```
■ :SENS:CURR:RANG
```

```
■ :SENS:CURR:RANG:AUTO
```

For example, to select the Auto range mode,

```
OUTPUT 717;":SENS:CURR:RANG:AUTO ON"
```

For example, to select the 1 nA range,

```
OUTPUT 717;":CURR:RANG:AUTO OFF"
OUTPUT 717;":CURR:RANG 1E-9"
```

To Set the Averaging Rate

The following commands set the averaging rate:

```
■ :SENS:AVER
```

```
■ :SENS:AVER:COUN
```

For example, to set the averaging rate to 4,

```
OUTPUT 717;":AVER:COUN 4"
```

To Set Trigger Delay Time

The following command sets the trigger delay time:

```
■ :TRIG:DEL
```

For example, to set the trigger delay time to 10 ms,

```
OUTPUT 717;":TRIG:DEL 1E-2"
```

To Set the Parameters for Resistivity Measurements

The following commands set the parameters for resistivity measurements:

- :CALC:RES:STH
- :CALC:RES:EPER
- :CALC:RES:GLEN
- :CALC:RES:EAR

For example, to measure the volume resistivity, when the thickness of DUT is 2 mm, and when you use the ϕ 50 mm electrode and 70 mm guard ring of the HP 16008B Resistivity Cell, that is,

Thickness is 0.002 m

Effective Area is 0.0019635 ($= \pi \times (0.05/2)^2$) m²

Effective Perimeter is 0.1885 ($= \pi \times (0.05+0.07)/2$) m

Gap is 0.01 ($= (0.07-0.05)/2$) m.

```
OUTPUT 717;":SENS:FUNC 'RES'"
```

```
OUTPUT 717;":CALC:FORM VRES"
```

```
!
```

```
OUTPUT 717;":CALC:RES:STH 0.002"
```

```
OUTPUT 717;":CALC:RES:EAR 0.0019635"
```

```
OUTPUT 717;":CALC:RES:EPER 0.1885"
```

```
OUTPUT 717;":CALC:RES:GLEN 0.01"
```

To Set Beeper Mode

The following commands set the beeper mode:

- :SYST:BEEP
- :SYST:BEEP:STAT
- :CALC1:LIM:BEEP
- :CALC1:LIM:BEEP:COND

For example, to set the beeper mode to emit a beep when comparison result is PASS.

```
OUTPUT 717;":CALC1:LIM:BEEP:COND PASS"
```

To Lock Out the Front Panel Keys

The following command locks out the front panel keys:

- :SYST:KLOC

For example, to lock out the front panel keys,

```
OUTPUT 717;":SYST:KLOC ON"
```

To Check Contact Integrity at the Test Fixture

The following command checks contacts at the test fixture:

- :SENS:RES:CONT:VER

For example, to enable the contact check function,

```
OUTPUT 717;":SENS:RES:CONT:VER ON"
```

To Use the Comparator Function

The following commands control the comparator function:

- CALC:LIM:CLE
- CALC:LIM:FAIL?
- CALC:LIM:LOW
- CALC:LIM:LOW:STAT
- CALC:LIM:UPP
- CALC:LIM:UPP:STAT
- CALC:LIM:STAT

For example, to set the limit values and to enable the comparator function,

```

:
OUTPUT 717;":CALC:LIM:LOW 1E10"
OUTPUT 717;":CALC:LIM:UPP 1E11"
OUTPUT 717;":CALC:LIM:STAT ON"
OUTPUT 717;":FETC?"
ENTER 717;S,D,C
:

```

To Display a Deviation Measurement

The following commands display deviation results:

- :DATA
- :CALC:MATH:EXPR:NAME
- :CALC:MATH:EXPR:CAT?
- :CALC:MATH:STAT

For example, to set the reference value using a measurement value and to calculate the absolute deviation value,

```

:
OUTPUT 717;":FETC?"
ENTER 717;s,d
OUTPUT 717;":DATA REF,";d
OUTPUT 717;":CALC:MATH:EXPR:NAME DEV"
OUTPUT 717;":CALC:MATH:STAT ON"
:

```

To Set the Offset-Error Canceling Function

The following command set the offset-error canceling function ON or OFF:

- :CAL:AUTO

For example, to select the offset-error canceling function OFF,

```
OUTPUT 717;":CAL:AUTO OFF"
```

To Wait Until Previously Sent Commands are Completed

The following commands make the HP 4339A wait until the previously sent commands are completed:

- *OPC
- *OPC?
- *WAI

Getting Started

HP 4339A

For example, to wait until the OPEN correction is completed,

```
OUTPUT 717;":SENS:CORR:COLL STAN1"   Perform OPEN correction
OUTPUT 717;"*OPC?"                   Wait for OPEN correction completed
ENTER 717;A
```

To Get the Current Instrument Settings

The following command gets the current instrument settings:

■ *LRN?

For example,

```
DIM A$[1000]
:
OUTPUT 717;"*LRN?"
ENTER 717;A$
PRINT A$
```

To Save and Recall Instrument Settings

The following commands save and recall instrument settings:

■ *SAV

■ *RCL

To save the instrument settings to register no. 1,

```
OUTPUT 717;"*SAV 1"
```

To recall the instrument settings from register no. 1,

```
OUTPUT 717;"*RCL 1"
```

To Trigger a Measurement

The following commands are used to trigger measurements from an external controller and to handle the HP 4339A's trigger system. Refer to "Trigger System" in Chapter 5 for the information about the HP 4339A's trigger system.

- :TRIG
- :TRIG:SOUR
- :INIT
- :INIT:CONT
- :ABOR
- *TRG
- :FETC?
- Group Execution Trigger (GET)

To set the Internal trigger mode:

```

:
OUTPUT 717;":TRIG:SOUR INT"      Internal trigger mode
OUTPUT 717;":INIT:CONT ON"      Continuously initiating trigger system
LOOP                               Retrieve the data
  OUTPUT 717;":FETC?"
  ENTER 717;S,D                  Get the data
  PRINT S,D
END LOOP
:

```

To set to the Manual trigger mode:

```

:
OUTPUT 717;":STAT:OPER:ENAB 16"  Enable Measuring bit of Operation Status Register
OUTPUT 717;":*SRE 128"          Enable Operation Status Register Summary bit
ON INTR 7 GOSUB Data_available   Tells where to branch when interrupted
ENABLE INTR 7;2                 Enable an interrupt when measurement ends
!                               Manual trigger mode
OUTPUT 717;":TRIG:SOUR MAN"
OUTPUT 717;":ININ:CONT ON"      Continuously initiating trigger system
LOOP                               Retrieve the data
  LOCAL 717 ! Press the Trig key.
END LOOP
!
Data_available: !
  OUTPUT 717;":FETC?"
  ENTER 717;S,D                  Get the data
  PRINT S,D                      Clear the SRQ bit
  A=SPOLL(717)
  OUTPUT 717;":STAT:OPER?"      Clear Operation Status Register
  ENTER 717;A
  ENABLE 7;2
RETURN
:

```

To set to the External trigger mode:

```

:
OUTPUT 717;":STAT:OPER:ENAB 16"  Enable Measuring bit of Operation Status Register
OUTPUT 717;":*SRE 128"           Enable Operation Status Register Summary bit
ON INTR 7 GOSUB Data_available    Tells where to branch when interrupted
ENABLE INTR 7;2                   Enable an interrupt when measurement ends
!
OUTPUT 717;":TRIG:SOUR EXT"       External trigger mode
OUTPUT 717;":ININ:CONT ON"        Continuously initiating trigger system
LOOP !                             Apply trigger signal
END LOOP                           from the external trigger source
!                                   Retrieve the data
Data_available: !
OUTPUT 717;":FETC?"               Get the data
ENTER 717;S,D                     Clear the SRQ bit
PRINT S,D
A=SPOLL(717)
OUTPUT 717;":STAT:OPER?"          Clear Operation Status Register
ENTER 717;A
ENABLE 7;2
RETURN
:

```

To set to the Bus trigger mode:

Using the *TRG Command,

```

:
OUTPUT 717;":TRIG:SOUR BUS"       Bus trigger mode
OUTPUT 717;":INIT:CONT ON"        Continuously initiating trigger system
OUTPUT 717;":*TRG"                Trigger a measurement
ENTER 717;S,D                     Get the data
PRINT S,D
:

```

Using the Group Execution Trigger (GET):

```

:
OUTPUT 717;":TRIG:SOUR BUS"       Bus trigger mode
OUTPUT 717;":INIT:CONT ON"        Continuously initiating trigger system
TRIGGER 717                        Trigger a measurement
ENTER 717;S,D                     Get the data
:

```

To trigger a measurement regardless of the trigger source:

```

:
OUTPUT 717;":TRIG"   Trigger a measurement
OUTPUT 717;":FETC?"  Retrieve the data
ENTER 717;S,D       Get the data
:

```

Data Retrieval

After triggering, the output format is,

<stat>,*<data>*,*<comp>*

Where,

<i><stat></i>	Measurement status
	0 : Normal
	1 : Overload
	2 : No-Contact
	4 : Over current (exceeding current limit)
<i><data></i>	Measurement data
<i><comp></i>	Comparison result (no output when the comparator function is OFF)
	0 : OFF
	1 : In
	2 : High
	4 : Low
	4 : No-Contact

To Retrieve Data Efficiently

The basic procedure to retrieve measurement data is described in "To Trigger a Measurement". This section describes how to retrieve the measurement data efficiently.

To Transfer Data Using Real data Format

The following command transfers data faster by using the real data format:

■ FORM REAL

```

ASSIGN @Dt TO 717;FORMAT OFF
:
OUTPUT 717;":FORM REAL"
OUTPUT 717;":FETC?"
ENTER @Dt USING "#,4A";A$
ENTER @Dt;S,D
ENTER @Dt USING "#,A";A$
PRINT S,D
:

```

To Use Data Buffer

The following commands use the data buffer function:

- :DATA:POIN
- :DATA:FEED
- :DATA:FEED:CONT
- :DATA?

For example,

```

:
OPTION BASE 1
DIM D(1000)
:
OUTPUT 717;":TRIG:SOUR BUS"
!
OUTPUT 717;":DATA:POIN DBUF,500"
OUTPUT 717;":DATA:FEED DBUF,'CALC'"
OUTPUT 717;":DATA:FEED:CONT DBUF,ALW"
!
FOR I=1 TO 500
  OUTPUT 717;":TRIG"
NEXT I
!
OUTPUT 717;":DATA? DBUF"
ENTER 717;D(*)
PRINT D(*)
:

```

To Perform a Measurement Sequence

The following commands perform the sequence measurement:

- :ARM:SOUR
- :ARM:DEL
- :TRIG:SOUR
- :TRIG:TIM
- :TRIG:COUN

Warning



When the HP 4339A is in the sequence measurement mode, triggering a measurement may output a dangerous voltage levels up to 1000 Vdc. Do not touch the UNKNOWN terminals or the electrodes of the accessory, when the V output indicator is ON.

- To perform the single measurement sequence:

```

:
OUTPUT 717;":SOUR:VOLT 10"      Test Voltage: 10 V
OUTPUT 717;":ARM:SOUR BUS"      Measurement Sequence: ON, Trigger Source: Bus
OUTPUT 717;":ARM:DEL 60"        Charge time: 60 s
OUTPUT 717;":TRIG:SOUR INT"     Single mode
OUTPUT 717;":INIT:CONT ON"
OUTPUT 717;"*TRG"
ENTER 717;S,D
PRINT S,D
:

```

- To perform the continuous measurement sequence:

```

OPTION BASE 1
DIM D(20)
:
OUTPUT 717;":SOUR:VOLT 10"      Test Voltage: 10 V
OUTPUT 717;":ARM:SOUR BUS"      Measurement sequence: ON, Trigger Source: Bus
OUTPUT 717;":ARM:DEL 60"        Charge time: 60 s
OUTPUT 717;":TRIG:SOUR TIM"     Continuous mode
OUTPUT 717;":TRIG:TIM 30"       Interval time: 30 s
OUTPUT 717;":TRIG:COUN 10"      Memory size: 10
OUTPUT 717;":INIT:CONT ON"
OUTPUT 717;"*TRG"
ENTER 717;D(*)
PRINT D(*)
:

```

Other Features

To Test the HP 4339A

The following command runs the HP 4339A's internal self test:

■ *TST?

For example,

```

:
OUTPUT 717;"*TST?"
ENTER 717;A
IF A<>0 THEN PRINT "Self Test: Error"
IF BIT(A,0) THEN PRINT "RAM Test Error"
IF BIT(A,1) THEN PRINT "EPROM Test Error"
IF BIT(A,2) THEN PRINT "Calibration Data Test Error"
IF BIT(A,3) THEN PRINT "User's Data Test Error"
IF BIT(A,4) THEN PRINT "A/D Converter Test Error"
IF BIT(A,5) THEN PRINT "Backup Memory Test Error"
:

```

To Read the Error Queue

The following command returns the number and message of the existing error in the error queue.

■ :SYST:ERR?

For example,

```

:
DIM Err$[50]
:
REPEAT
  OUTPUT 717;":SYST:ERR?"
  ENTER 717;Errnum,Err$
  PRINT Errnum,Err$
UNTIL Errnum=0
:

```

To Report the Instrument's Status

The following commands report the instrument's status:

- *CLS
- *ESE
- *ESR?
- *SRE
- *STB?
- :STAT:OPER?
- :STAT:OPER:COND?
- :STAT:OPER:ENAB
- :STAT:QUES?
- :STAT:QUES:COND?
- :STAT:QUES:ENAB
- :STAT:PRES

■ HP BASIC SPOLL command

For example, to detect the measurement completion:

```

OUTPUT 717;":SYST:OPER:ENAB 16"  Enable Measurement bit of Operation Status Register
OUTPUT 717;"*SRE 128"           Enable Operation Status Register Summary bit
REPEAT                            Wait until the Operation Status Register Summary
  A=SPOLL(717)                   bit is set
UNTIL BIT(A,7)

```

For example, to generate an interrupt when an error occurs in the HP 4339A:

```

:
DIM Err$(50)
!
:
OUTPUT 717;"*CLS"                 Clears status byte register
OUTPUT 717;"*ESE 48"             Sets Command Error Bit and Execution Error Bit
OUTPUT 717;"*SRE 32"            Sets Standard Event Status Register Summary Bit
!
ON INTR 7 GOSUB Err_report       Tells where to branch to when interrupted
ENABLE INTR 7;2                  Enable an interrupt from HP-IB interface
!
:
LOOP
:
END LOOP
STOP
!
Err_report:
  Stat=SPOLL(717)                 Clears the SRQ bit
  OUTPUT 717;"*ESR?"             Asks contents of the Standard Event Status Register
  ENTER 717;Estat
  PRINT "Syntax Error detected."
  !
  OUTPUT 717;":SYST:ERR?"        Asks to output error number and message
  ENTER 717;Err,Err$
  PRINT Err,Err$
  !
  ENABLE INTR 7
  RETURN
END

```

Sample Program

The following sample program measures resistivity of insulation film using the HP 16008B Resistivity Cell with $\phi 50$ mm main electrode.

Warning Do *NOT* touch the UNKNOWN terminals or the electrodes of the accessory, when the High Voltage indicator is ON, the HP 4339A outputs dangerous voltage levels up to 1000 Vdc. Before handling the HP 4339A or the accessory, confirm that the High Voltage indicator is OFF.



```

10  ASSIGN @Hp4339 TO 717
20  !
30  OUTPUT @Hp4339;"*RST;*CLS"
40  OUTPUT @Hp4339;":INIT:CONT ON"
50  !
60  DISP "Calibration"
70  OUTPUT @Hp4339;":CAL?"
80  ENTER @Hp4339;A
90  DISP
100 IF A<>0 THEN
110   PRINT "Error:",A
120   PAUSE
130 END IF
140 !
150 DISP "Separate each electrode and close the top cover,
then press 'Continue'."
160 PAUSE
170 DISP "OPEN Correction"
180 OUTPUT @Hp4339;":SENS:FUNC 'CURR'"
185 OUTPUT @Hp4339;":SENS:CURR:APER 0.39'"
190 OUTPUT @Hp4339;":SOUR:VOLT 500"
200 OUTPUT @Hp4339;":OUTP ON"
210 REPEAT
220   OUTPUT @Hp4339;"FETC?"
230   ENTER @Hp4339;S,D
240 UNTIL ABS(D)<5.E-13
250 OUTPUT @Hp4339;":SENS:CORR:COLL OFFS"
260 OUTPUT @Hp4339;"*OPC?"
270 ENTER @Hp4339;A
280 OUTPUT @Hp4339;":OUTP OFF"
290 DISP "Confirm that the High Voltage indicator is OFF,
then press 'Continue'."
300 PAUSE
310 DISP "Place DUT and close the top cover, then press
'Continue'."
320 PAUSE
330 DISP
340 !
350 OUTPUT @Hp4339;":ARM:SOUR BUS"
360 OUTPUT @Hp4339;":ARM:DEL 60"
370 OUTPUT @Hp4339;":TRIG:SOUR INT"
380 !
390 OUTPUT @Hp4339;":CALC:RES:STH 0.002"
400 OUTPUT @Hp4339;":CALC:RES:EAR 0.0019635"

```



```

410 OUTPUT @Hp4339;":CALC:RES:EPER 0.18850"
420 OUTPUT @Hp4339;":CALC:RES:GLEN 0.01"
430 !
440 OUTPUT @Hp4339;":SENS:FUNC 'RES'"
450 DISP "Turn the Volume/Surface selector to 'Volume'."
460 PAUSE
470 DISP
480 OUTPUT @Hp4339;":CALC:FORM VRES"
490 OUTPUT @Hp4339;":*TRG"
500 ENTER @Hp4339;S,D
510 PRINT "Volume Resistivity:",D;"[OHMcm]","Status:";S
520 !
530 DISP "Turn the Volume/Surface selector to 'Surface'."
540 PAUSE
550 DISP
560 OUTPUT @Hp4339;":CALC:FORM SRES"
570 OUTPUT @Hp4339;":*TRG"
580 ENTER @Hp4339;S,D
590 PRINT "Surface Resistivity:",D;"[OHM]","Status:";S
600 END

```

Figure 4-2. Sample Program

Lines 30 and 40	Presets the HP 4339A, clears the status byte register, and sets the trigger system being continuously initiated.
Lines 60 to 130	Performs calibration. If any error occurs during calibration, check what error occurs and stop the program.
Lines 150 to 330	Performs an OPEN correction: <ol style="list-style-type: none"> 1. Selects the Current measurement mode. 2. Selects the Long measurement time mode. 3. Apply the test voltage, 500 V. 4. Wait until the current has stabilized to within 0.5 pA. 5. Performs an OPEN correction.
Lines 350 to 370	Sets the sequence measurement parameter: <p>Measurement sequence mode: Single mode Charge time: 60 s Trigger source: Bus</p>
Line 390	Sets the DUT thickness to 2 mm.
Lines 400 to 420	Sets the resistivity cell parameters for $\phi 50$ mm main electrode: <p>Effective area: $19.635 (= \pi \times (5.0/2)^2)$ cm² Effective perimeter: $18.850 (= \pi \times (5.0 + 7.0)/2)$ cm Gap: 1 cm</p>
Lines 440 to 510	Measures the volume resistivity.
Lines 530 to 590	Measures the surface resistivity.

If You Have a Problem

Check all HP-IB addresses and connections; most HP-IB problems are caused by an incorrect address or bad or loose HP-IB cables.

If the HP 4339A Hangs Up When You Send the ABORT Command

- Send the device clear command to the HP 4339A:

For example,

`CLEAR(717)`

HP-IB Reference

Introduction

This chapter provides the information needed to control the HP 4339A through the HP-IB interface in the HP-IB Remote mode.

- HP-IB Command Reference
- Status Reporting
- Trigger System
- Data Transfer Format

HP-IB Commands

The HP 4339A's HP-IB commands are compatible with the Standard Commands for Programmable Instruments (ACPI). SCPI is the instrument command language for controlling instruments that go beyond IEEE 488.2 standard to address a wide variety of instrument functions in standard manner.

Commands can be separated into two groups: common commands and subsystem commands.

Common Commands

Common commands are generally not measurement related, but are used to manage macros, status registers, synchronization, and data storage. All common commands begin with an asterisk (*). Common commands are defined in the IEEE 488.2 standard.

Subsystem Commands

Subsystem commands include all measurement functions and some general purpose functions. Each subsystem is a set of commands that roughly corresponds to a functional block inside the instrument.

Subsystem commands have a hierarchical structure, called a **command tree**, which consists of several key words separated by a colon between each word.

Subsystem Command Tree

The top of the subsystem command tree is called the **root command**, or simply the **root**. To reach low-level commands, you must specify a particular **path** (like DOS file directory path). After power ON or after *RST, the current path is set to the root. The path settings are changed as follows:

Message Terminator A message terminator, such as the <new line> character, sets the current path to the root.

Colon (:)

When a colon is placed between two command mnemonics, the colon moves the current path down one level on the command tree. When the colon is the first character of a command, it specifies the following command mnemonic is a root-level command.

Semicolon (;)

A semicolon separates two commands in the same message without changing the current path.

Figure 5-1 shows examples of how to use the colon and semicolon to navigate efficiently through the command tree.

Common commands, such as *RST, are not part of any subsystem. The HP 4339A interprets them in the same way, regardless of the current path setting.

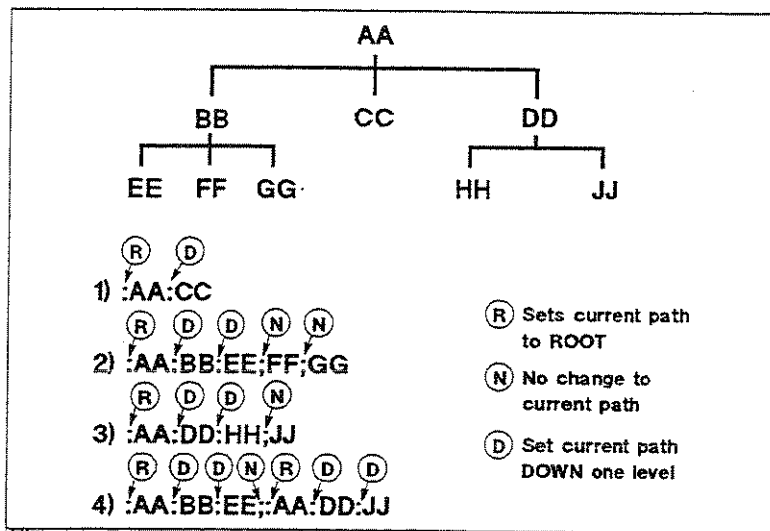

Figure 5-1. Proper Use of the Colon and Semicolon

Program Message Syntax

This section provides the construction of SCPI program message. A program message is the message that you send from a computer to an instrument. Program messages consist of commands combined with appropriate punctuation and program message terminators.

Command Abbreviations

Many commands have a long and a short form. In this manual, all commands are spelled out in a longer form. The Short form is obtained by deleting the lower case letters.

For example, the short form of :INITiate is :INIT and the long form of it is :INITIATE. (SCPI does not accept anything in between, such as :INITIA.)

Case

Letter cases (upper and lower) are ignored.

Program Message Terminator

Program message must be ended with one of the three **program message terminators**, <new line>, <^END>, or <new line><^END>. <^END> means that End Of Identify (EOI) is asserted on the HP-IB interface at the same time the preceding data byte is sent. For example, the HP BASIC OUTPUT statement is automatically sent after the last data byte. If you are using a PC, you can usually configure your system to send whatever terminator you specify.

Common Command Syntax

Common commands do not have a hierarchical structure. They can be sent as follows:

*CLS

Subsystem Command Syntax

Subsystem commands consist of the mnemonic (keyword) separated by colons. For example, the command form of CONTInuous under INITiate subsystem is constructed as follows:

:INITiate:CONTInuous

Parameters

There must be a <space> between the last command mnemonic and the first parameter in a subsystem command.

:SYSTem:LFRequency \sqcup parameter

\sqcup means a space (ASCII character (decimal 32)) is inserted here.

If you send more than one parameter with a single command, each parameter must be separated by a comma.

Parameter Types

SCPI defines different data formats for use in program messages and query responses. The HP 4339A accepts commands and parameters in various formats and responds to a particular query in a predefined and fixed format. Each command reference contains information about the parameter types available for the individual commands.

<numeric_value> Is used in both common commands and subsystem commands.
<numeric_value> represents a numeric parameter as follows:

100	no decimal point required
100.	fractional digits optional
-1.23, +235	leading signs allowed
4.56e \sqcup 3	space allowed after e in exponential
-7.89E-01	use either E or e in exponential
.5	digits left of decimal point optional

The HP 4339A setting programmed with a numeric parameter can assume a finite number of values, so the HP 4339A automatically rounds off the parameter. For example, the HP 4339A has a programmable line frequency of 50 or 60 Hz. If you specified 50.1, it would be rounded off to 50.

The subsystem commands use extended numeric parameters. Extended numeric parameters accept all numeric parameter values and other special values, for instance, MAXimum, MINimum or UP, DOWN. The special values available are described in the command's reference description.

Query response of *<numeric_value>* is always a numeric value in *<NR1>* (integer) or *<NR3>* (floating point) format.

■ **Suffix** When a command has specified suffix, the suffix multiplier and suffix units can be used with parameters as follows. (The suffix multiplier must be used with the suffix unit.):

Voltage : V (V; default), KV (kV)

Current: PA (pA), NA (nA), UA (μ A), MA (mA), A (A; default)

Time: MS (ms), S (s; default)

The suffix is optional and can be omitted.

<Boolean> Represents a single binary condition that is either ON or OFF. *<Boolean>* allows the following parameters:

ON, OFF in a program message.

1, 0 in a program message and query response.

<sensor_function> and *<data_handle>* Are string parameters which contain ASCII characters. A string must begin with a single quote (ASCII 39 decimal) or a double quote (ASCII 34 decimal) and end with the same character, a single or double quote. The quote to mark the beginning and end of the string is called the delimiter. You can include the delimiter as part of the string by typing it twice without any characters in between.

Example of *<sensor_function>* "RES",

OUTPUT @Meter;":SENS:FUNC 'RES'" *using single quote*

OUTPUT @Meter;":FSENS:FUNC ""RES"" *using double quote*

A query response is the string in between double quote delimiters.

Multiple Messages

To send more than one command in the same message, you must separate them with a semicolon:

```
*CLS;:INIT
```

Query and Response Message Syntax

All subsystem commands can be queried except for the commands described as "no query" in the command reference. To send a query message, add a question mark, ? after the last command mnemonic.

```
:AVER:COUN?
```

A response message may contain both commas and semicolons as separators. When a single query command returns multiple values, a comma is used to separate each data item. When multiple queries are sent in the same message, the group of data items corresponding to each query are separated by a semicolon. For example, the fictitious query :QUERY1?;QUERY2? might return a response message of:

```
<data1>,<data1>;<data2>,<data2>
```

HP 4339A

HP-IB Commands

After the message, Note that <new line><^END> is always sent as a response message terminator.

5 HP-IB Reference

Command Reference

Notations

In this chapter, each subsystem is documented using the tabular format instead of the command tree as follows. The following conventions and definitions are used to describe HP-IB operation.

COMMAND	PARAMETER
FORMat	
[:DATA]	{ASCI REAL[,64]}

COMMAND	PARAMETER
INITiate	
:CONTinuous	<Boolean>
[:IMMediate]	

Commands closest to the root-level are at the top of the table. Lower nodes in the hierarchy are indented one position to the right.

If a command requires one or more parameters, the parameter names are listed adjacent to the command.

The lower case parts are optional.

- < > Angular brackets enclose words or characters that are used to symbolize a program code parameter or an HP-IB command.
- [] Square brackets indicate that the enclosed items are optional.
- { } When several items are enclosed by braces, one and only one of these elements may be selected. A vertical bar can be read as "or" and is used to separate alternative parameter options.

- For example, the :FORMat[:DATA] command can be

```
:FORMAT:DATA
:FORM:DATA
:FORMAT
```

- For example, the {ASCI|REAL[,64]} parameter can be

```
ASCII
ASC
REAL,64
REAL
```

ABORt Command

:ABORt

Resets the trigger system and places all trigger sequences in Idle state. Any actions related to the trigger system that are in progress, such as acquiring a measurement, are aborted immediately. The execution of an :ABORt command will set any pending operation flag to FALSE, for example flags that were set by the initiation of the trigger system. Refer to "Trigger System".

Unlike *RST, :ABORt does not alter the settings programmed by other commands. (No query)

Note



After the :FETCh? query, the *TRG command, or the TRIGGER BASIC command, the :ABORt command will cause the HP-IB bus to hang up. To avoid this, clear the HP-IB bus by sending the BASIC command CLEAR(*address*) before sending the :ABORt command.

ARM Subsystem

The HP 4339A has the measurement sequence feature which provides a measurement sequence (charging DUT, and then measuring it several time with interval) by a single operation — triggering a measurement. The ARM subsystem controls the sequence measurement feature, working with the TRIGger subsystem.

The purpose of the ARM subsystem is to qualify an ARMIing sequence, before enabling the TRIGger system, to charge the DUT before measuring it.

For details about the ARM-TRIGger system model, see “Trigger System”.

COMMAND	PARAMETER
ARM	
[:SEQuence1]	
[:LAYer]	
:DELay	<numeric_value>[MS S]
:SOURce	{BUS EXTernal MANual IMMediate}

:ARM[:SEQuence1][:LAYer]:DELay <numeric_value> [MS|S]

Sets the DUT charging time before a DUT is measured. The charge time defines the waiting time when the HP 4339A triggered a measurement to when the measurement will actually start. The test voltage is applied during this time.

<numeric_value> is,

numeric 0.000 to 9.999 (s)

:ARM[:SEQuence1][:LAYer]:SOURce {BUS|EXTernal|MANual|IMMediate}

Sets the sequence measurement mode to ON or OFF, and selects the source for the ARM event detector. When the ARM event is detected, the HP 4339A enables the output test voltage and applies the test voltage to DUT. After charge-time wait, HP 4339A move from the ARM event detection state to the TRIG event detection state.

When BUS, EXTernal, or MANual is selected as the ARM source, the HP 4339A automatically enables the test voltage output at the time an ARM event is detected, and applies the test voltage to the DUT. After the measurement, the HP 4339A automatically turns OFF the test voltage output. When IMMEDIATE is selected, the ARM event has no effect on test voltage output enabling or disabling, you must control test voltage output.

Only one trigger source can be specified at a time for a given event detector. The available trigger sources are:

Parameter	Measurement Sequence	Trigger Source
BUS	ON	GET or *TRG commands
EXTernal		An external trigger signal from external trigger terminal
MANual		The front-panel <small>See AD017</small>  key.
IMMediate	OFF	No waiting for a ARM event to occur. (The HP 4339A immediately advances to the TRIG event detection state.)

Query response format is BUS, MAN, INT, or IMM.

CALCulate Subsystem

The CALCulate subsystem controls measurement data processing listed below.

1. To select measurement parameter (CALCulate:FORMat subsystem with CALCulate:RESistivity subsystem)
2. To control deviation measurement mode (CALCulate:MATH subsystem)
3. To control comparator function (CALCulate:LIMit subsystem)

The HP 4339A performs data processing in the order it is listed.

The CALCulate subsystem is logically between the SENSE subsystem and data output to either the bus or the display, and works with the SENSE subsystem, the DATA subsystem, and FETCh? query.

COMMAND	PARAMETER
CALCulate	
:FORMat	{REAL SRESistivity VRESistivity}
:LIMit	
:BEEPer	
:CONDition	{FAIL PASS}
[:STATe]	<Boolean>
:CLEar	
:FAIL?	
:LOWer	
[:DATA]	<numeric_value>
:STATe	<Boolean>
:STATe	<Boolean>
:UPPer	
[:DATA]	<numeric_value>
:STATe	<Boolean>
:MATH	
:EXPRession	
:CATAlog?	
:NAME	{DEV PCNT}
:STATe	<Boolean>
:PATH?	
:RESistivity	
:EAREa	<numeric_value>
:EPERimeter	<numeric_value>
:GLENgth	<numeric_value>
:STHickness	<numeric_value>

:CALCulate:FORMat { REAL | SRESistivity | VRESistivity }

Specifies or queries the post-processing of measurement data, which is measured using the *<sensor_function>* specified by the [SENSe]:FUNction command. The definition of the SENSE subsystem parameters are as follows:

<i><sensor_function></i> of [:SENSe]:FUNction	CALCulate:FORMat	Parameter
"CURRent:DC"	REAL	current: I [A]
"RESistance[:DC]"	REAL	resistance: R [Ω]
	SRESistivity	surface resistivity: $\frac{P \times R}{g}$ [Ω]
	VRESistivity	volume resistivity: $\frac{A}{t} \times R$ [$\Omega \times cm$]

Where,

Parameter	Description	Command
P [m]	Effective perimeter	CALCulate:RESistivity:EPERimeter
g [m]	Gap between main electrode and guard electrode (ring)	CALCulate:RESistivity:GLENGth
A [m ²]	Effective area	CALCulate:RESistivity:EAREa
t [m]	Thickness of sample	CALCulate:RESistivity:STHickness

Query response is REAL, SRES, or VRES.

:CALCulate:LIMit:BEEPer:CONDition { PASS | FAIL }

Defines comparator output to beeper.

- FAIL a beep is emitted when the comparison result is FAIL (High, Low or No-contact).
- PASS a beep is emitted when the comparison result is PASS (In).

This command is effective when SYSTem:BEEPer:STATe and CALCulate:LIMit:BEEPer:STATe commands are set to ON.

Query response is FAIL or "PASS".

:CALCulate:LIMit:BEEPer[:STATe] { ON | OFF | 1 | 0 }

Sets or queries if comparator output to beeper is enabled.

- ON or 1 Enables the comparator output to beeper as defined by :CALCulate:LIMit:BEEPer:CONDition command.
- OFF or 0 Disables comparator output to beeper.

To enable the beeper function, you must set :SYSTem:BEEPer:STATe command to ON. Query response is 1 or 0.

:CALCulate:LIMit:CLEar

Clears the data which is reported by CALCulate:LIMit:FAIL? command. (no query)

:CALCulate:LIMit:FAIL?

Returns the comparison result. (Query only)

Query response is 1 or 0.

Where,

1 Comparison result is FAIL.
0 Comparison result is PASS.

:CALCulate:LIMit:LOWer[:DATA] <numeric_value>

Sets or queries lower limit data.

<numeric_value> is,

numeric Real. Range is -9.9×10^{37} to 9.9×10^{37} .

Query response is a numeric value in <NR3> format.

:CALCulate:LIMit:LOWer:STATe { ON | OFF | 1 | 0 }

Sets or queries if the lower test limit is enabled.

ON or 1 Enables the lower limit.
OFF or 0 Disables the lower limit.

Query response is 1 or 0.

:CALCulate:LIMit:STATe { ON | OFF | 1 | 0 }

Sets or queries if the limit test is enabled.

Where,

ON or 1 Sets the comparison function to ON.
OFF or 0 Sets the comparison function to OFF.

Query response is 1 or 0.

:CALCulate:LIMit:UPPer[:DATA] <numeric_value>

Sets or queries the upper test limit data.

<numeric_value> is,

numeric -9.9×10^{37} to 9.9×10^{37}

A query response is a numeric value in <NR3> format.

:CALCulate:LIMit:UPPer:STATe { ON | OFF | 1 | 0 }

Sets or queries if the upper test limit is enabled.

Where,

ON or 1 Disables the upper limit.
OFF or 0 Enables the upper limit.

Query response is 1 or 0.

:CALCulate:MATH:EXPRession:CATalog?

Returns available parameters which are used with CALCulate:MATH:EXPRession:NAME command. (query only)

For more information, see CALCulate:MATH:EXPRession:NAME command.

Query response is DEV,PCNT.

:CALCulate:MATH:EXPRession:NAME { DEV | PCNT }

Defines or queries the expression used for deviation measurement, which is enabled by CALCulate:MATH:STATe. The reference value can be defined using the DATA[:DATA] command.

DEV	Absolute value of deviation
PCNT	Percentage of deviation

:CALCulate:MATH:STATe { ON | OFF | 1 | 0 }

Sets or queries if math processing defined by :CALCulate:MATH:EXPRession:NAME is enabled or not.

ON, 1	Enables math processing.
OFF, 0	Disables math processing.

Query response is 1 or 0.

:CALCulate:PATH?

Returns the order in which the CALCulate subsystem commands are to be performed. (Query only)

The HP 4339A always processes measured data in order of :CALCulate:FORMat subsystem, :CALCulate:MATH subsystem, and :CALCulate:LIMit subsystem.

Query response is always FORM,MATH,LIM.

:CALCulate:RESistivity:EARea <numeric_value >

Specifies or queries the effective area of the main electrode for the resistivity measurement.

<numeric_value> is,

numeric 0 to 0.99999 (m²)

Query response is a numeric value in <NR3> format.

:CALCulate:RESistivity:EPERimeter <numeric_value >

Specifies or queries the effective perimeter of the electrode for the resistivity measurement.

<numeric_value> is,

numeric 0 to 9.9999 (m)

Query response is a numeric value in <NR3> format.

:CALCulate:RESistivity:GLENgtH <numeric_value >

Specifies or queries the distance between the main electrode and guard electrode (ring) for the resistivity measurement.

<numeric_value> is,

numeric 0.00001 to 0.9999 (m)

Query response is a numeric value in <NR3> format.

:CALCulate:RESistivity:STHickness <numeric_value >

Specifies or queries the thickness of the sample for the resistivity measurement.

<numeric_value> is,

numeric 0.00001 to 0.02 (m)

Query response format is a numeric value in <NR3>.



CALibration Subsystem

COMMAND	PARAMETER
CALibration	
[:ALL]?	
:AUTO	<Boolean>

:CALibration[:ALL]?

Performs a calibration, and then returns an error code. The error code is referred to "Messages" at the back of this manual (An error code of "0" indicates no failure).

:CALibration:AUTO { ON | OFF }

Sets or queries if the offset-error canceling function is enabled. Refer to "Configuration Key  " in Chapter 3 for more information of the offset-error canceling function.

ON, 1 enables offset-error canceling
 OFF, 0 disables offset-error canceling

Query response is 1 or 0

DATA Subsystem

The DATA subsystem is used to store data to the HP 4339A's data buffer and to read data in the data buffer.

COMMAND	PARAMETER
DATA	
[:DATA]	REF, <numeric_value>
[:DATA]?	DBUF
:FEED	DBUF, <data_handle>
:CONTROL	DBUF, {ALWays NEVer}
:POINTs	DBUF, <numeric_value>

DATA[:DATA] REF, <numeric_value>

Enters or queries the reference value for the deviation measurement, which is controlled by :CALCulate:MATH subsystem commands.

<numeric_value> is,

numeric -9.9×10^{37} to 9.9×10^{37}

The query form requires parameter REF, such as :DATA[:DATA]?REF. Query response is a numeric value in <NR3> format.

DATA[:DATA]? DBUF

Returns the data in data buffer, DBUF, according to the format determined by the FORMat subsystem commands. (query only)

This query needs parameter DBUF which is the name of the data buffer to read.

Query response is, <set1>, <set2>, ... <setn>

Where,

<set1> : Data set of the first measurement point
 <set2> : Data set of the second measurement point
 :
 <setn> : Data set of the last measurement point (*n* is specified using DATA:POINTs DBUF command)

Each data set consists of the following data: <stat>, <data>, <comp>

Where,

<stat> Measured status
 0 : Normal
 1 : Overload
 4 : Over-current (exceeding current limit)
 <data> Measured data
 <comp> Comparison result
 0 : Comparator off
 1 : In
 2 : High
 4 : Low
 8 : No-contact

HP-IB Reference

:DATA:FEED DBUF,<data_handle>

Sets or queries which data is fed into the data buffer.

<data_handle> is,

- "CALCulate" set to feed the data specified CALCulate:FORMat command into the data buffer.
""(null string) set not to feed data into data buffer

The query form requires parameter DBUF, such as DATA:FEED? DBUF. Query response is "CALC" or null string.

:DATA:FEED:CONTROL DBUF,{ ALWAYS | NEVER }

Sets or queries whether data is fed into data buffer or not. The data fed into the data buffer by this command is specified by :DATA:FEED DBUF command. This command has no effect when :DATA:FEED DBUF is set to ""(null string).

Where,

- ALWays Feeds data into data buffer, whenever new data is available
NEVer No data is fed into data buffer

The query form requires parameter DBUF, such as DATA:FEED:CONT? DBUF. Query response is ALW or NEV.

:DATA:POINTs DBUF,<numeric_value>

Sets or queries the size of data buffer, DBUF. You can store as many measurement point data sets into DBUF as defined by this command.

<numeric_value> is,

- numeric 1 to 500

The query form requires parameter DBUF, such as :DATA:POINTs? DBUF. Query response is a numeric value in <NR1>.

DISPlay Subsystem

COMMAND	PARAMETER
DISPlay	
:WINDow	
[:STATe]	<Boolean>
:TEXT	
:PAGE	{1 2 3}

:DISPlay[:WINDow][:STATe] { ON | OFF | 1 | 0 }

Sets the display ON or OFF, or queries whether the display is set to ON or OFF.

Where,

ON or 1 Sets the display ON.
 OFF or 0 Sets the display OFF (blank).

Query response is 1 or 0.

:DISPlay[:WINDow]:TEXT:PAGE { 1|2|3 }

Sets or queries the display mode.

1 Measure Display
 2 Comparison Display
 3 Limit Table Display

Query response is 1, 2, or 3.

FETCh? Query

:FETCh?

Retrieves a measurement value taken using the INITiate subsystem commands and places the measurement data into the HP 4339A's output buffer. (Query only)

Query response format is,

<stat>,*<data>*,*<comp>*

Where,

<stat> measurement status
0 : Normal
1 : Overload
2 : No-Contact
4 : Over-Current (exceeding current limit)

<data> Measurement data

<comp> Comparison result (no output when the comparator function is OFF)
1 : In
2 : High
4 : Low
8 : No-Contact

Data format is specified by the FORMat [:DATA] command.

FORMat Subsystem

COMMAND	PARAMETER
FORMat [:DATA]	{ASCIi REAL[,64]}

:FORMat[:DATA] { ASCIi | REAL[,64] }

Sets the data format for transferring numeric and array information.

ASCIi Sets the data transfer format to ASCII.
REAL[,64] Sets the data transfer format to IEEE 754 floating point numbers of the
 specified length of 64-bit.

For details on data transfer formats, see "Data Transfer Format".

Query response is ASC or REAL,64.

INITiate Subsystem

The INITiate subsystem controls the initiation of the trigger system. All trigger sequences are initiated as a group. The detailed description of the trigger system is given in "Trigger System".

COMMAND	PARAMETER
INITiate	
:CONTinuous	<Boolean>
[:IMMediate]	

:INITiate[:IMMediate]

Causes all sequences to exit Idle state and enter Initiate state. Then the trigger system initiates and completes one full trigger cycle. Finally, on completion, the system returns to IDLE state. (No query)

If the HP 4339A is not in Idle state or if :INITiate:CONTinuous is set to ON, an :INITiate:IMMediate command has no effect on the trigger system and an error -213 is generated.

:INITiate:CONTinuous { ON | OFF | 1 | 0 }

Sets or queries whether the trigger system is continuously initiated or not.

OFF or 0 Does not initiate the trigger system continuously.
ON or 1 Initiates the trigger system continuously.

Query response is 0 or 1.

OUTPut Subsystem

The OUTPut subsystem controls the voltage source.

COMMAND	PARAMETER
OUTPut [:STATe]	<Boolean>

:OUTPut[:STATe] { ON | OFF | 1 | 0 }

Controls or queries whether the source voltage is ON or OFF.

ON or 1 Turns the source voltage ON.
OFF or 0 Turns the source voltage OFF.

Query response is 1 or 0.

Warning



Sending :OUTPut[:STATe] { ON | 1 } may cause the HP 4339A to output dangerous voltage levels up to 1000 Vdc. Do *NOT* touch the UNKNOWN terminals or the electrodes of the accessory, when the V Output indicator is ON.

SENSe Subsystem

COMMAND	PARAMETER
[SENSe]	
:AVERage	
:COUNT	<numeric_value>
[:STATe]	<Boolean>
:CORRection	
:COLLect	
[:ACQuire]	OFFSet
[:STATe]	<Boolean>
:CURRent	
:APERture	<numeric_value>[MS S]
:RANGe	
:AUTO	<Boolean>
[:UPPer]	<numeric_value>[PA NA UA A]
:FUNCTion	<sensor_function>
:RESistance	
:CONtact	
:VERify	<Boolean>

[[:SENSe]:AVERage:COUNT <numeric_value>

Sets or queries the averaging rate.

<numeric_value> is,

numeric 1 to 256

Query response format is a numeric value in <NR1> format.

[[:SENSe]:AVERage[:STATe] { ON | OFF | 1 | 0 }

Sets or queries if the averaging function is enabled.

Where,

ON or 1 Enables averaging.

OFF or 0 Disables averaging.

Query response is 1 or 0.

[[:SENSe]:CORRection:COLLect[:ACQuire] OFFSet

Measures and stores the OPEN correction data. (No query)

This command sets [SENSe]:CORRection[:STATe] ON, which enables the correction function.

[[:SENSe]:CORRection[:STATe] { ON | OFF | 1 | 0 }

Sets or queries if the OPEN correction function is enabled.

Where,

ON or 1 Enables the correction function.

OFF or 0 Disables the correction function.

[[:SENSE]:CURRENT:APERTure <numeric_value>[MS|S]

Sets or queries the measurement time mode: Short(=0.01 s), Medium(=0.03 s), Long(=0.39 s).

<numeric_value> is,

numeric 0.01, 0.03, or 0.39 (s)

Query response is a numeric value in <NR2> format.

[[:SENSE]:CURRENT:RANGE:AUTO { ON | OFF | 1 | 0 }

Sets or queries if the Auto range measurement mode is enabled.

Where,

ON or 1	Auto range mode
OFF or 0	Hold range mode

Query response is 1 or 0.

[[:SENSE]:CURRENT:RANGE[:UPPER] <numeric_value>[PA|NA|UA|A]

Selects or queries the measurement range. Available measurement ranges are 100 pA, 1 nA, 10 nA, 100 nA, 1 μ A, 10 μ A, and 100 μ A.

<numeric_value> is,

numeric 100 p (10⁻¹⁰), 1 n (10⁻⁹), 10 n (10⁻⁸), 100 n (10⁻⁷), 1 μ (10⁻⁶), 10 μ (10⁻⁵), 100 μ (10⁻⁴) (A)

UP	moves to upper range.
DOWN	moves to lower range.

Query response is a numeric value in <NR3> format.

[[:SENSE]:FUNCTION <sensor_function>

Sets or queries the measurement parameter. When an *RST command is executed, this is set to "RESistance[:DC]".

<sensor_function> is

'CURRENT[:DC]'	Current measurement
'RESistance[:DC]'	Resistance measurement

To measure surface or volume resistivity, calculate the value using the :CLACulate:FORMat command.

Query response is "CURR" or "RES".

[[:SENSE]:RESistance:CONTACT:VERIFY { ON | OFF | 1 | 0 }

Sets or queries if the contact check function is enabled.

Where,

ON or 1	Enables the contact check function.
OFF or 0	Disables the contact check function.

The reference data for the contact check is obtained by an OPEN correction.

Query response is 1 or 0.

SOURCE Subsystem

COMMAND	PARAMETER
SOURCE	
:CURRENT	
:LIMIT	
[:AMPLITUDE]	<numeric_value> [MA A]
:VOLTAGE	
[:LEVEL]	
[:IMMEDIATE]	
[:AMPLITUDE]	<numeric_value> [KV V]

:SOURCE:CURRENT:LIMIT[:AMPLITUDE] <numeric_value> [MA|A]

Sets or queries the current limit value.

<numeric_value> is,

numeric 0.5 m(0.0005), 1 m(0.001), 2 m(0.002), 5 m(0.005), 10 m(0.01) (A)

Query response is a numeric value, in <NR2> format.

:SOURCE:VOLTAGE[:LEVEL][:IMMEDIATE][:AMPLITUDE]
 <numeric_value> [KV|V]

Sets or queries the source voltage value.

<numeric_value> is,

numeric 0.0 to 1000.0 (V)

Query response is a numeric value in <NR2> format.

STATus Subsystem

The STATus subsystem commands control the Operation Status and Questionable Status registers in the status-reporting structures (See "Status Reporting Structure").

COMMAND	PARAMETER
STATus	
:OPERation	
:CONDition?	
:ENABle	<numeric_value>
[:EVENT]?	
:PRESet	
:QUEStionable	
:CONDition?	
:ENABle	<numeric_value>
[:EVENT]?	

:STATus:OPERation:CONDition?

Returns the contents of the condition register of the Operation Status Register group. Reading the condition register does not clear it. (Query only)

Query response is a numeric value in <NR1> format.

:STATus:OPERation:ENABle <numeric_value>

Sets the enable register of the Operation Status Register group.

<numeric_value> is,

numeric Decimal expression of the contents of the register

Query response is a numeric value in <NR1> format.

:STATus:OPERation[:EVENT]?

Returns the contents of the event register of the Operation Status Register group. Reading the event register clears it. (Query only)

Query response is a numeric value in <NR1> format.

:STATus:PRESet

Clears the Operation Status and Questionable Status register groups. Both the event and enable registers are cleared. (no query)

:STATus:QUEStionable:CONDition?

Returns the contents of the condition register of the Standard Questionable Status Register group. (Query only)

Query response is always 0, because the HP 4339A has no operation to report the event to the Questionable Status condition register.

:STATus:QUESTionable:ENABLE <numeric_value>

Sets or queries the enable register of the Questionable Status Register group.

<numeric_value> is,

numeric Decimal expression of the contents of the register.

The HP 4339A has no operation to report the event to the Questionable Status Condition Register.

Query response is a numeric value in <NR1> format.

:STATus:QUESTionable[:EVENT]?

Returns the contents of the event register of the Questionable Status Register group. (query only)

Query response is always 0, because the HP 4339A has no operation to report the event to the Questionable Status Event Register.

SYSTEM Subsystem

The SYSTEM subsystem reports the SCPI version and error, sets the beeper, disables front-panel key input, and sets the line frequency.

COMMAND	PARAMETER
SYSTEM	
:BEEPer	
[:IMMEDIATE]	
:STATe	<Boolean>
:ERRor?	
:KLOCK	<Boolean>
:LFRequency	<numeric_value>
:PRESet	
:VERSion?	

:SYSTEM:BEEPer[:IMMEDIATE]

Produces a beep immediately. (no query)

:SYSTEM:BEEPer:STATe { ON | OFF | 1 | 0 }

Sets or queries if the beeper is enabled.

Where,

ON or 1 Disables all beeper functions, including the error beep.
 OFF or 0 Enables the beeper.

Query response is 1 or 0.

:SYSTEM:ERRor?

Returns the number and Message of the existing error numbers in the HP 4339A's error queue. (Query only)

Query response is a numeric number in <NR1> format and a string parameter.

:SYSTEM:KLOCK { ON | OFF | 1 | 0 }

Sets or queries whether the front-panel keys of the HP 4339A are locked.

OFF or 0 Locks the front-panel keys.
 ON or 1 Does not lock the front-panel keys.

Query response is 0 or 1.

:SYSTEM:LFRequency <numeric_value>

Sets or queries the HP 4339A's operating power line frequency.

<numeric_value> is,

numeric 50 or 60 (Hz)

Query response is a numeric value in <NR3> format.

:SYSTEM:PRESet

Resets the HP 4339A to its default states. (No query) The default states are given in Table 3-3.

:SYSTEM:VERSion?

Returns the value corresponding to SCPI version to which the instrument complies. (Query only)

Query response is YYYY.V.

Where,

YYYY	Year-version
V	Revision number for the year

TRIGger Subsystem

The TRIGger subsystem controls the measurement trigger function. For a detailed description about the trigger sequence controlled by the TRIGger subsystem, see "TRIG Event Detection State" in "Trigger System", later in this chapter.

COMMAND	PARAMETER
TRIGger	
[:SEquence1]	
:COUNt	<numeric_value>
:DELay	<numeric_value>[MS S]
[:IMMediate]	
:SOURce	{BUS EXTernal INTernal MANual TIMer}
:TIMer	<numeric_value>[MS S]

:TRIGger[:SEquence1]:COUNt <numeric_value>

Sets or queries the size of memory when performing a Continuous measurement sequence.

<numeric_value> is,

numeric 1 to 500

Query response is a numeric value in <NR1> format.

:TRIGger[:SEquence1]:DELay <numeric_value>[MS|S]

Sets or queries the trigger delay time.

<numeric_value> is,

numeric 0.000 to 9.999 [s]

Query response is a numeric value in <NR3> format.

:TRIGger[:SEquence1][:IMMediate]



Causes the trigger to execute a measurement, regardless of the trigger state. (No query)

:TRIGger[:SEQuence1]:SOURce {BUS|EXTErnal|INTernAl|MANual|TIMer}

Sets or queries a trigger source. Only one source can be specified at a time.

The TRIGger[:SEQuence1]:SOURce command works with the ARM[:SEQuence1][:LAYer]:SOURce command and controls the measurement sequence mode. The selections of the TRIGger:SOURce and ARM:SOURce is shown in Table 5-1.

Table 5-1. Selection of ARM Source and Trigger Source

ARM:SOUR ¹	TRIG:SOUR	Measurement Sequence	Trigger Source
IMMediate	BUS	OFF	GET or a *TRG command
	EXTErnal		An external signal from the external trigger terminal
	INTernAl		An internal signal
	MANual		 key
	TIMer	Not Available ²	
BUS	BUS	Not Available ³	
	EXTErnal		
	MANual		
	INTernAl	Single	GET or *TRG command
TIMer	Continuous		
EXTErnal	BUS	Not Available ³	
	EXTErnal		
	MANual		
	INTernAl	Single	An external trigger signal from the external trigger terminal
TIMer	Continuous		
MANual	BUS	Not Available ³	
	EXTErnal		
	MANual		
	INTernAl	Single	 key
TIMer	Continuous		

1 For details on ARM:SOURce, see ARM[:SEQuence1][:LAYer] command.

2 If you select this TRIGger:SOURce, the HP 4339A automatically sets ARM:SOURce to BUS.

3 If you select these TRIGger:SOURce, the HP 4339A automatically sets ARM:SOURce to IMMediate.

Query response is BUS, EXT, INT, MAN, or TIM.

:TRIGger[:SEQuence1]:TIMer <numeric_value>[MS|S]

Sets the period of the internal periodic signal source.

<numeric_value> is,

numeric 0 to 999 [s]

Query response is a numerical value in <NR3> format.

Common Commands

***CLS**

Clears the Status Byte Register, the Standard Event Status Register, the Operation Status Register, and the Questionable Status Register. (No query)

***ESE <numeric_value>**

Sets or queries the bits of the Standard Event Status Enable Register.

<numeric_value> is,

numeric A decimal expression of the contents of the Standard Event Status Enable Register

Query response is a numeric value in <NR1> format.

***ESR?**

Queries the contents of the Standard Event Status Register. (Query only)

Query response is a numeric value in <NR1> format.

***IDN?**

Queries an identification string which consists of four fields separated by commas. (Query only)

Query response is <Field 1>,<Field 2>,<Field 3>,<Field 4>.

Where,

Field 1: Manufacturer (always HEWLETT-PACKARD)
Field 2: Model number (always 4339A)
Field 3: Serial number in HP format (like 2419J00100)
Field 4: Firmware version number (like 01.00)

***LRN?**

Returns a sequence of commands that defines the HP 4339A's current state. (Query only)

***OPC**

Tells the HP 4339A to set bit 0 (OPC bit) in the Standard Event Status Register when it completes all pending operations.

*OPC? tells the HP 4339A to place an ASCII character 1 into the Output Queue when it completes all pending operations.

***RCL <numeric_value>**

Recalls the instrument state previously stored in the specified register number. The HP 4339A has 10 available storage registers. (No query)

<numeric_value> is,

numeric 0 to 9

***RST**

Returns the HP 4339A to its default state and sets the following commands. (See Table 3-3):

```
INITiate:CONTinuous OFF
[SENSe:]CORRection[:STATe] OFF
SYSTem:KLOCK OFF
```

(No query)

***SAV <numeric_value>**

Saves the instrument state in the specified register number. The HP 4339A has 10 available storage registers. (No query)

<numeric_value> is,

numeric 0 to 9

***SRE <numeric_value>**

Sets the bits of the Status Byte Enable Register.

<numeric_value> is,

numeric decimal expression of the contents of the Status Byte Enable Register (Bit 6 must be always 0)

Query response is a numeric value in <NR1> format.

***STB?**

Queries the contents of the Status Byte Register. (Query only)

Query response is a numeric value in <NR1> format.

***TRG**

Triggers the HP 4339A when the trigger mode is set to Bus trigger mode. (No query)

Warning

When the HP 4339A is in the sequence measurement mode, sending *TRG may cause the HP 4339A to output dangerous voltage levels up to 1000 Vdc. Do *NOT* touch the UNKNOWN terminals or the electrodes of the accessory, when the V Output indicator is ON.

***TST?**

Executes an internal self-test and returns the test result as the sum of the error codes of all existing errors. If there is no error the HP 4339A returns a 0.

Test Item	Error Code
1. RAM	1
2. EPROM	2
3. Calibration data (EEPROM)	4
4. User's data (EEPROM)	8
5. AD converter	16
6. Backup RAM	32

Query response is a numeric value in <NR1> format.

***WAI**

Makes the HP 4339A wait until all previously sent commands are completed. (No query)

Status Reporting Structure

This section provides information about the status reporting structure for Service Request functions which correspond to SCPI.

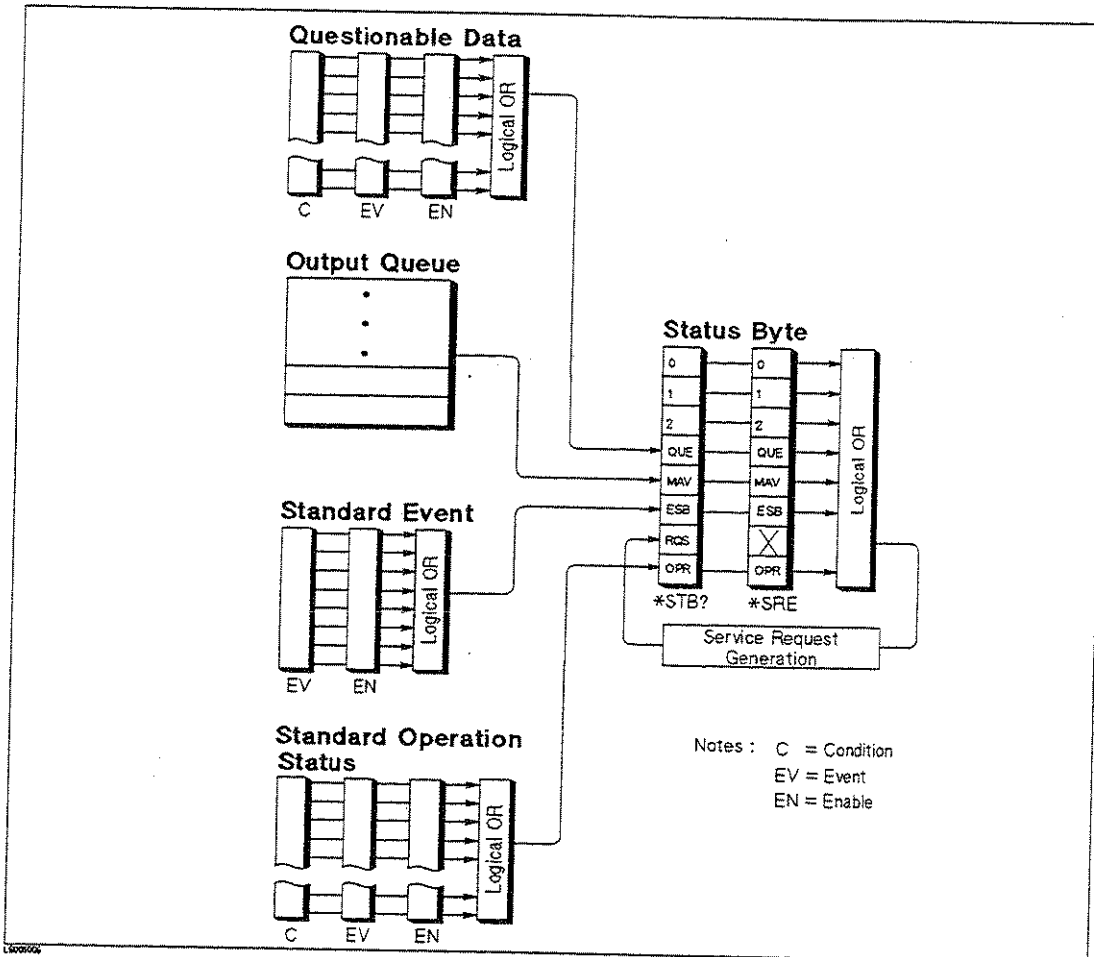

Figure 5-2. Status Reporting Structure

Service Request (SRQ)

The HP 4339A can send an SRQ (Service Request) control signal when it requires the controller to perform a task. When the HP 4339A generates an SRQ, it also sets Bit 6 of the Status Byte Register, RQS (Request Service) bit. Service Request Enable Register allows an application programmer to select which summary messages in the Status Byte Register may cause service requests. (Illustrated in Figure 5-3.)

Status Byte Register

The Status Byte Register is composed of eight bits that summarize an overlaying status data structure.

The Status Byte Register can be read using either *STB? or SPOLL, which return a decimal expression of the contents of the register (equal to the sum of the total bit weights of all the bits set to "1").

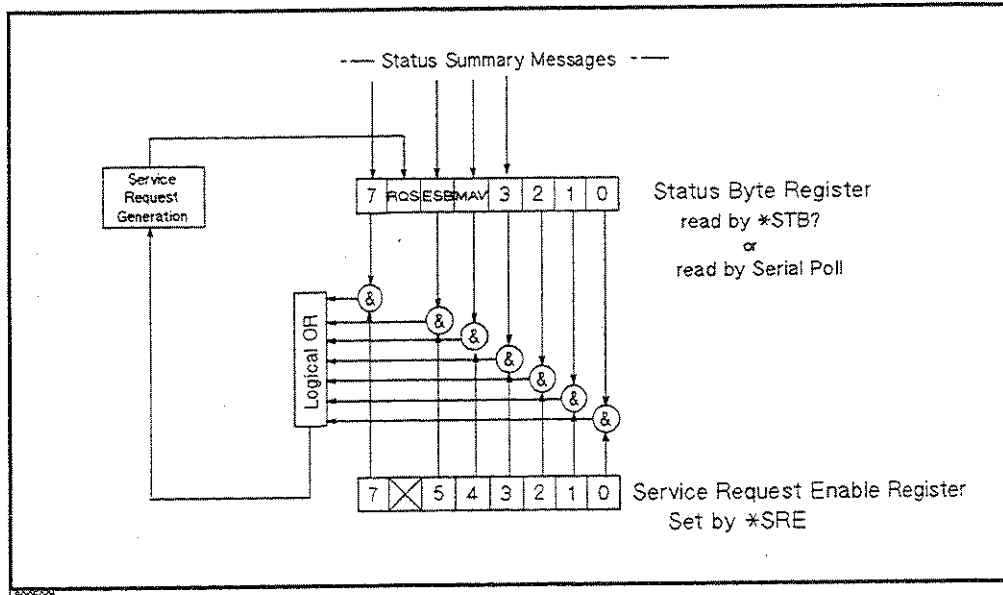

Figure 5-3. Status byte Register

Table 5-2. Status Byte Assignments

Bit No.	Bit Weight	Description
7	128	Operation Status Register Summary Bit
6	64	Request Service Bit — This bit is set when any enabled bit of the Status Byte Register has been set, which indicates HP 4339A has at least one reason for requesting service. SPOLL resets this bit.
5	32	Standard Event Status Register Summary Bit
4	16	Message Available Bit — This bit is set whenever the HP 4339A has data available in the Output Queue, and is reset when the available data is read.
3	8	Questionable Status Register Summary Bit
2-0		always 0 (zero)

HP-IB Reference

Standard Event Status Register

The Standard Event Status Register is frequently used and is one of the simplest. You can program it using HP-IB common commands, *ESE and *ESR?. Refer to *ESE command and *ESR? command in "Command Reference".

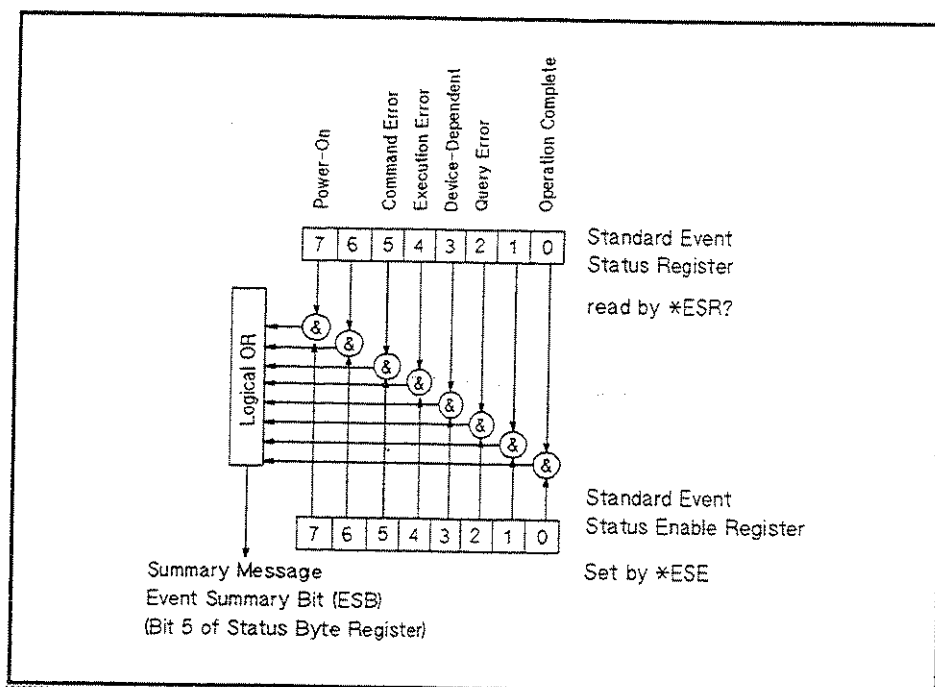

Figure 5-4. Standard Event Status Register

Table 5-3. Standard Event Status Register Assignments

Bit No.	Bit Weight	Description
7	128	Power-On Bit — This bit is set when the HP 4339A has been turned OFF and then ON since the last time this register was read.
6		always 0 (zero)
5	32	Command Error Bit — This bit is set if the following command errors occur. <ul style="list-style-type: none"> • An IEEE 488.2 syntax error occurred. • The HP 4339A received a Group Execute Trigger (GET) inside a program message.
4	16	Execution Error Bit — This bit is set when a parameter of a HP-IB command was outside of its legal input range or was otherwise inconsistent with the HP 4339A's capabilities.
3	8	Device-Dependent Error Bit — This bit is set when so many errors have occurred that the error queue is full.
2	4	Query Error Bit — This bit is set when reading data from the output buffer and no data was present, or when the data was lost.
1		always 0 (zero)
0	1	Operation Complete Bit — This bit is set when the HP 4339A has completed all selected pending operations before sending the *OPC command.

Standard Operation Status Group

The HP 4339A provides two Standard Operation Status groups — Operation Status Register group and Questionable Status Register group — which can be accessed using the STATUS subsystem commands. (Refer to STATUS subsystem in “Command Reference”.) This group is used in advanced programming. The individual bit assignment of these registers are given in “Operation Status Register” and “Questionable Status Register” later in this section.

Each group includes a condition register, an event register, and an enable register. (Illustrated in Figure 5-5.)

The condition register reflects the internal states of the HP 4339A. So each time the HP 4339A’s condition is changed, its condition bit is changed from “0” to “1”, or from “1” to “0”.

The event register’s bits correspond to the condition register’s bits. A transition filter reports an event to the event register, when a condition register bit changes from “1” to “0” for all bits, except for bit no. 8 and 9. For bit no.’s 8 and 9, reporting occurs when a condition register bit changes from “0” to “1”.

Note After the event register’s bits are set to 1, the bits are kept at 1 before reading or clearing them.



The enable register enables the corresponding bit in the event register to set the status summary bit, bit 7 or bit 3, of the Status Byte Register.

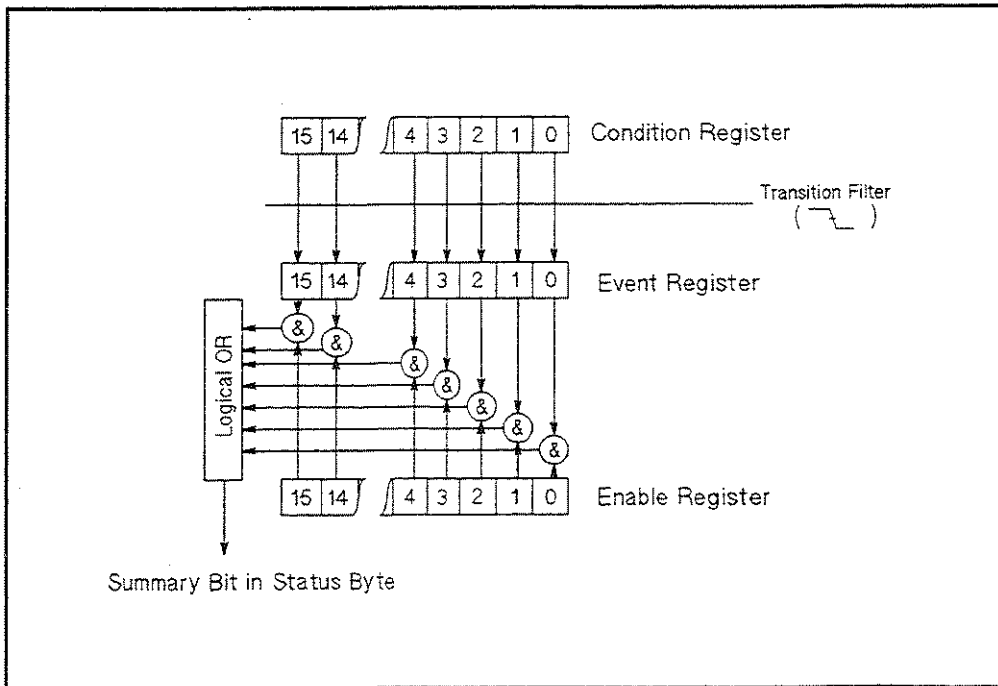

18005002

Figure 5-5. Standard Operation Status Group Structure

5-HP-IB Reference

Operation Status Register

The Operational Status Register group provides information about the state of the HP 4339A measurement system.

Table 5-4. Operation Status Condition Register Assignments

Bit No.	Bit Weight	Description
9-15		Always 0
8	256	DBUF is full — this bit is set when DBUF is full.
7	128	Correcting — This bit is set when the correction data measurement is in progress.
6	64	Waiting for ARM — This bit is set when the HP 4339A is in the ARM Event Detection State of the trigger system.
5	32	Waiting for Trigger — This bit is set when the HP 4339A is in the TRIG Event Detection State of the trigger system.
4	16	Measuring — This bit is set when the HP 4339A is actively measuring.
3		Always 0 (zero)
2	4	Ranging — This bit is set when the HP 4339A is currently changing its measurement range.
1	2	Settling — This bit is set when the HP 4339A is waiting for signals it controls to stabilize enough to begin a measurement.
0	1	Calibrating — This bit is set when the HP 4339A is currently performing a calibration.

Table 5-5. Operation Status Event Register Assignments

Bit No.	Bit Weight	Description
9-15		Always 0 (zero)
8	256	This bit is set when DBUF has become full.
7	128	This bit is set when the correction data measurement has completed.
6	64	This bit is set when the HP 4339A has been in the ARM Event Detection State of the trigger system.
5	32	This bit has been set when the HP 4339A has been in the TRIG Event Detection State of the trigger system.
4	16	This bit is set when the measurement has completed.
3		Always 0 (zero)
2	4	This bit is set when the ranging has been completed.
1	2	This bit is set when the settling has completed.
0	1	This bit is set when the calibration has completed.

Questionable Status Register

The HP 4339A has no operation to report the event to the Questionable Status Register group, all of whose bits are always 0. This register is available to keep consistency with other SCPI compatible instruments.

Trigger System

This section provides information about the trigger system of the HP 4339A. SCPI defines a common trigger model for several types of instruments. The trigger system allows you to have specific control of your measurements.

Information on the trigger system requires more technical expertise than most other topics covered in this chapter. But you can avoid having to learn the information in this section by using the :INITiate commands to make your measurements.

HP 4339A Trigger System Configuration

The trigger system synchronizes the HP 4339A measurement with specified events. Events include HP-IB trigger command or input pulse on Ext Trigger terminal. The trigger system also allows you to specify the number of times to repeat a measurement and the delays between measurements.

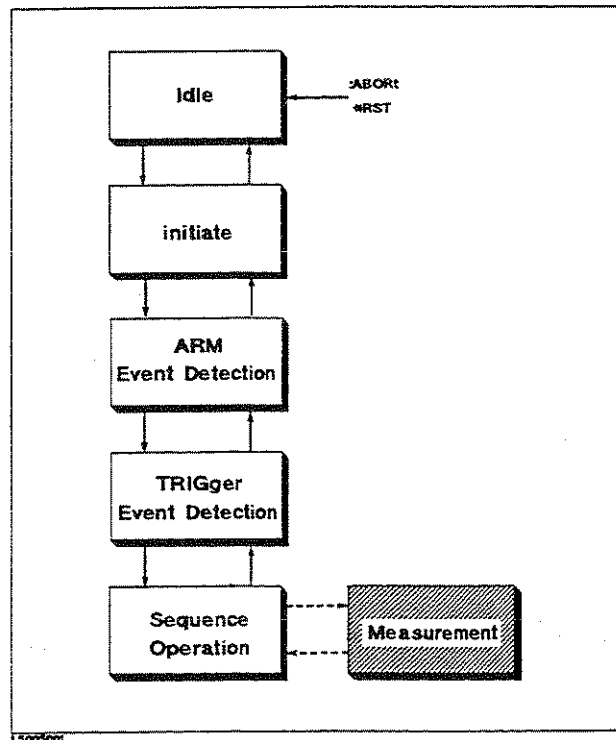

Figure 5-6. Trigger System Configuration

Figure 5-6 shows the configuration of the HP 4339A trigger system. Each block is a **trigger state**. The HP 4339A moves between adjacent states depending on its conditions. The power ON state is called the **Idle** state. You can force the HP 4339A to the idle state using the :ABORt or *RST command. The **Initiate**, **ARM Event Detection**, and **Trigger Event Detection** states branch to the next state when the HP 4339A satisfies the specified conditions. The **Sequence Operation** state signals the instrument hardware to take a measurement and waits for a signal indicating that the measurement has been taken.

Idle State

The trigger system remains in the idle state until it is initiated by :INITiate[:IMMediate] or :INITiate:CONTinuous ON commands. Once one of these conditions is satisfied, the trigger system exits downward to the initiate state. Note that *RST sets INITiate:CONTinuous OFF.

Initiate State

If the trigger system is on a downward path, it travels directly through the initiate state without restrictions. If the trigger system is on an upward path, and :INITiate:CONTinuous is ON, then it exits downward to an Trigger Event Detection state. If the trigger system is on an upward path and :INITiate:CONTinuous OFF, then it exits upward to the Idle state.

ARM Event Detection State

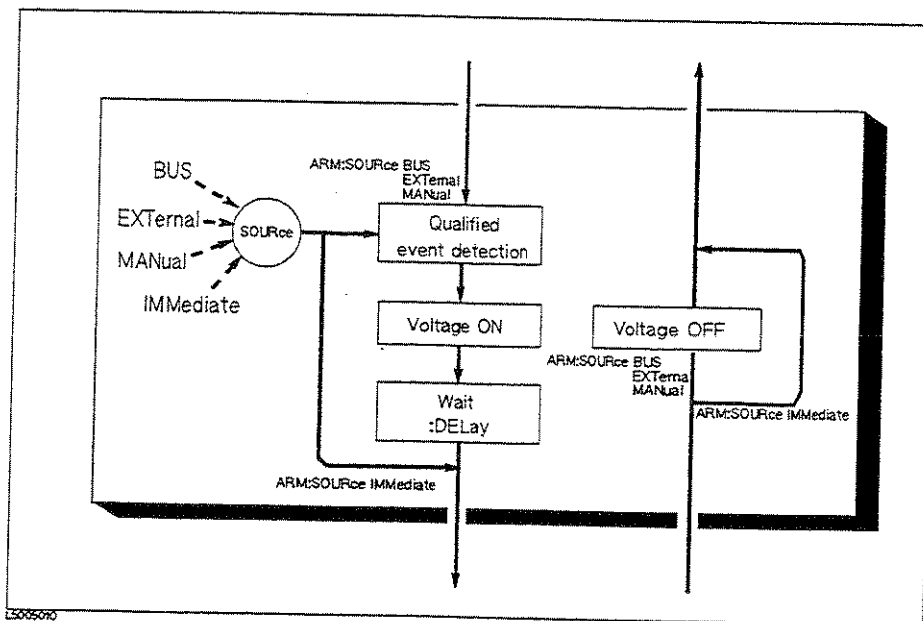

Figure 5-7. Inside an ARM Event Detection State

SOURCE

The :ARM[:SEqueNce1][:LAYer]:SOURce command selects an ARM event source. When the SOURCE is set to BUS, EXTeRnal, or MANual, the HP 4339A waits for the ARM event detection, and moves its state downward through "Voltage ON" and "Wait" state. When the SOURCE is set to IMMEDIATE, the HP 4339A immediately exits the ARM event detection state, without waiting the ARM event, and bypasses the "Voltage ON" and "Wait" states.

DElay

The :ARM[:SEqueNce1][:LAYer]:DElay command specifies a time duration between the recognition of an event and the downward exit. Sending an *RST command sets DElay to zero.

On the downward path, all the conditions for ARM must be satisfied before the TRIG events can be sensed.

TRIG Event Detection State

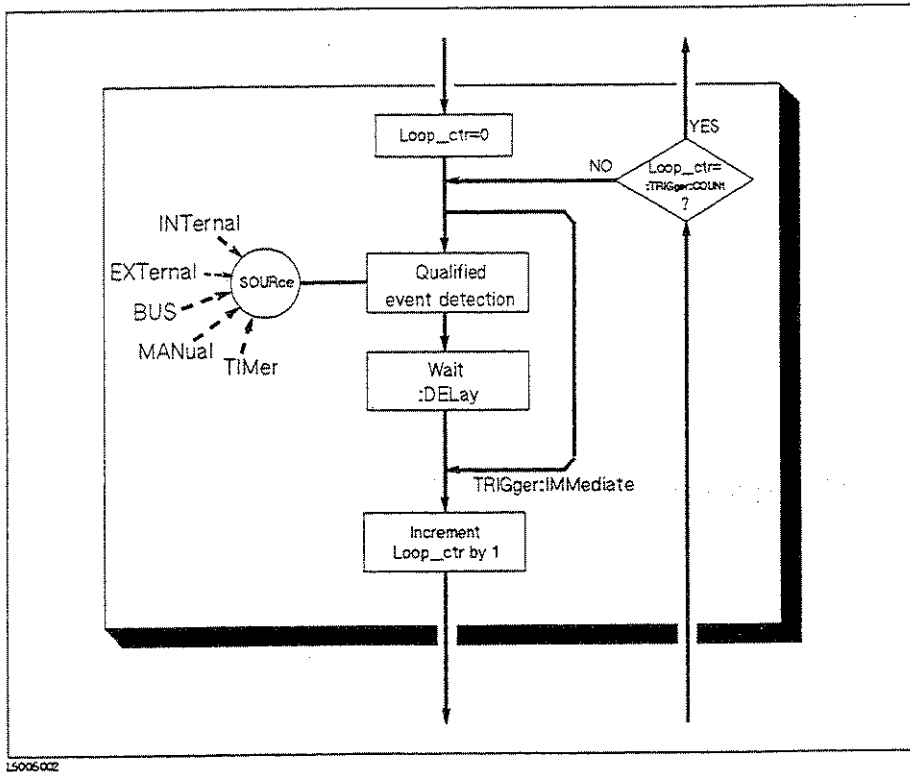

Figure 5-8. Inside a TRIG Event Detection State

- SOURCE** The :TRIGger[:SEquence1]:SOURCE command specifies which particular input can generate the event required to continue the downward path.
- DELay** The :TRIGger[:SEquence1]:DELay command specifies a time duration between the recognition of an event and the downward exit. Sending an *RST command sets DELay to zero.
- IMMediate** The :TRIGger[:SEquence1]:IMMediate command bypasses the event detection, DELay qualifications one time.
- COUNT** The :TRIGger[:SEquence1]:COUNT command controls the trigger system on an upward path through an TRIG Event Detection state. COUNT specifies how many downward exits must occur before an upward exit is allowed. Sending *RST sets COUNT to 1.

Sequence Operation State

The downward entrance to the sequence operation state forces the HP 4339A to start a measurement. An upward exit is not allowed until the measurement is complete.

5 HP-IB Reference

1
2
3
4
5
6
7
8
9
10
11
12
13
14
15
16
17
18
19
20
21
22
23
24
25
26
27
28
29
30
31
32
33
34
35
36
37
38
39
40
41
42
43
44
45
46
47
48
49
50
51
52
53
54
55
56
57
58
59
60
61
62
63
64
65
66
67
68
69
70
71
72
73
74
75
76
77
78
79
80
81
82
83
84
85
86
87
88
89
90
91
92
93
94
95
96
97
98
99
100

Application Measurement

Introduction

This chapter provides actual measurement examples for various types of devices. The measurement examples are:

- Measuring Insulation Resistance of Capacitors
- Measuring Resistivity of Insulation Materials
- Measuring Insulation Resistance of Electro-Mechanical Components

Measuring Insulation Resistance of Capacitors

This example shows insulation resistance measurement of a chip capacitor after it has been charged for 1 minute using the HP 16339A Component Test Fixture with the SMD module.

Warning Do *NOT* touch the UNKNOWN terminals or the electrodes of the accessory, when the High Voltage indicator is ON, the HP 4339A outputs dangerous voltage levels up to 1000 Vdc. Before handling the HP 4339A or the accessory, turn OFF the test voltage pressing  and confirm that the High Voltage indicator is OFF.

1. Connect the shunt connector and the HP 16339A to the HP 4339A. (For the HP 16339A, use the Chip Component Module Configuration as shown in the *HP 16339A Operation and Service Manual*).

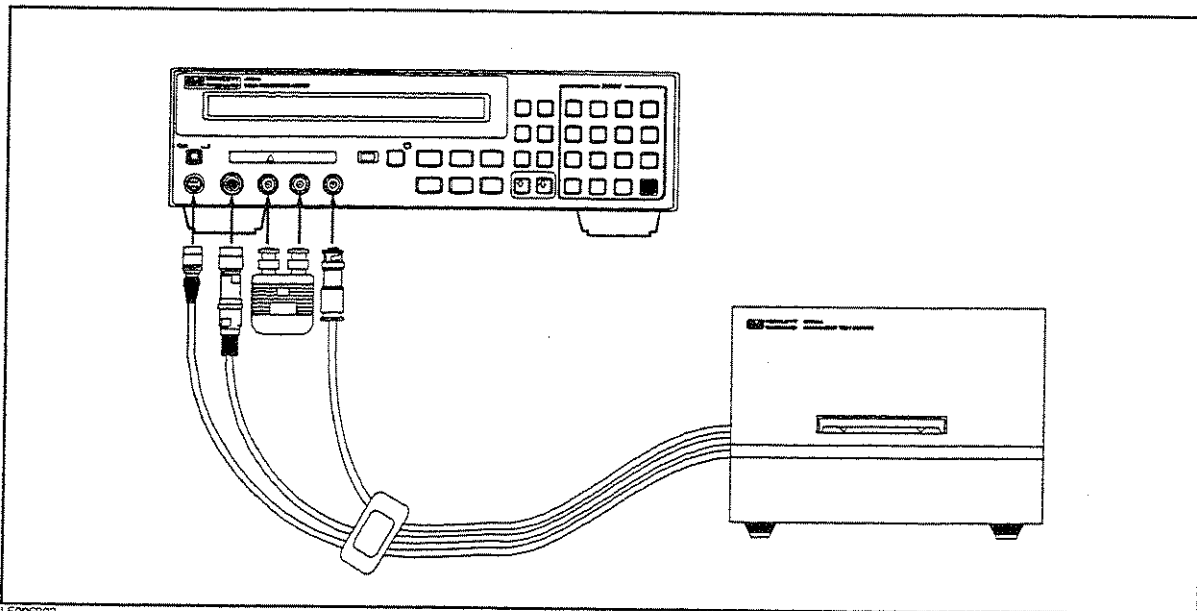













Figure 6-1. Measurement Configuration

2. Set the SMD module to the HP 16339A, and connect the High terminals and the Low terminals respectively using the miniature banana cables.
3. Reset the HP 4339A.
Press   to select the reset menu. Press  to select YES, then press .
4. Set the test voltage value.
Press . Enter the voltage value, for example 100 (V): Press .
5. Perform the calibration.
Press  .
6. Perform an OPEN correction.

- a. Remove DUT if connected, and set the SMD module's electrode contact spacing the same as the DUT's length, tightening the screw to hold this interval between the electrodes.
 - b. Close the top cover.
 - c. Select the Current measurement mode pressing  (I is displayed at the left end of the display).
 - d. Apply the source voltage pressing .
 - e. Wait until the current has stabilized to within 0.5 pA. (Displayed I values do not change by more than 0.5 pA.)
 - f. Start an OPEN correction by pressing  .
7. Clip the capacitor to the HP 16339A (see Figure 6-2), then close the top cover.

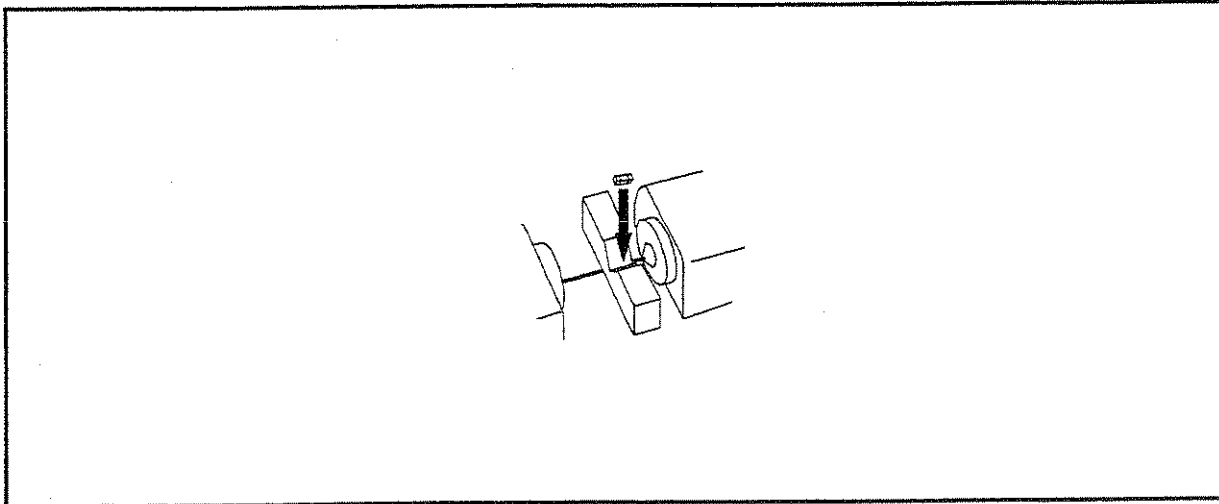









Figure 6-2. Chip Capacitor Binding

8. Select Resistance as the measurement parameter.
Press  until R is displayed on left end of the display.
9. Set the measurement sequence configuration.
Press  . Select CHARGE and press . Enter the charge time, for example 60 (s),
Press  twice.
10. Select the single mode as the measurement sequence mode.
Press  until the Sgl annunciator is ON.
11. Start the measurement sequence.
Press . Seq Running annunciator is displayed, and the HP 4339A applies the test voltage across the capacitor for 60 seconds.

Note

If you want to abort the measurement sequence, press

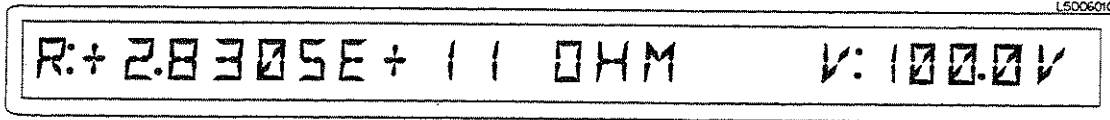

When the sequence measurement is finished, the annunciator is turned OFF and the measurement result is displayed.

**Figure 6-3. Measurement Result**

12. To exit the measurement sequence, press  twice.

The Sequence annunciator is turned OFF and the measurement sequence stops.

13. Wait until the High Voltage indicator is OFF. Then remove the DUT from the test fixture.

Measuring Resistivity of Insulation Materials

This section provides measurement example of resistivity of insulation film using the HP 16008B Resistivity Cell with the $\phi 50$ main electrode.

Warning



Do **NOT** touch the UNKNOWN terminals or the electrodes of the accessory, when the High Voltage indicator is ON, the HP 4339A outputs dangerous voltage levels up to 1000 Vdc. Before handling the HP 4339A or the accessory, turn OFF the test voltage pressing  and confirm that the High Voltage indicator is OFF.

Note



The thickness of the DUT should be measured accurately because thickness data is used to calculate volume resistivity. (see "Electrode Size Key  " in Chapter 3) To reduce the reading error when you measure a thickness using a micrometer, you should average the thickness values measured at several points in the measurement area and then use this average value to obtain the dielectric constant.

1. Connect the shunt connector and the HP 16008B to the HP 4339A as shown below.

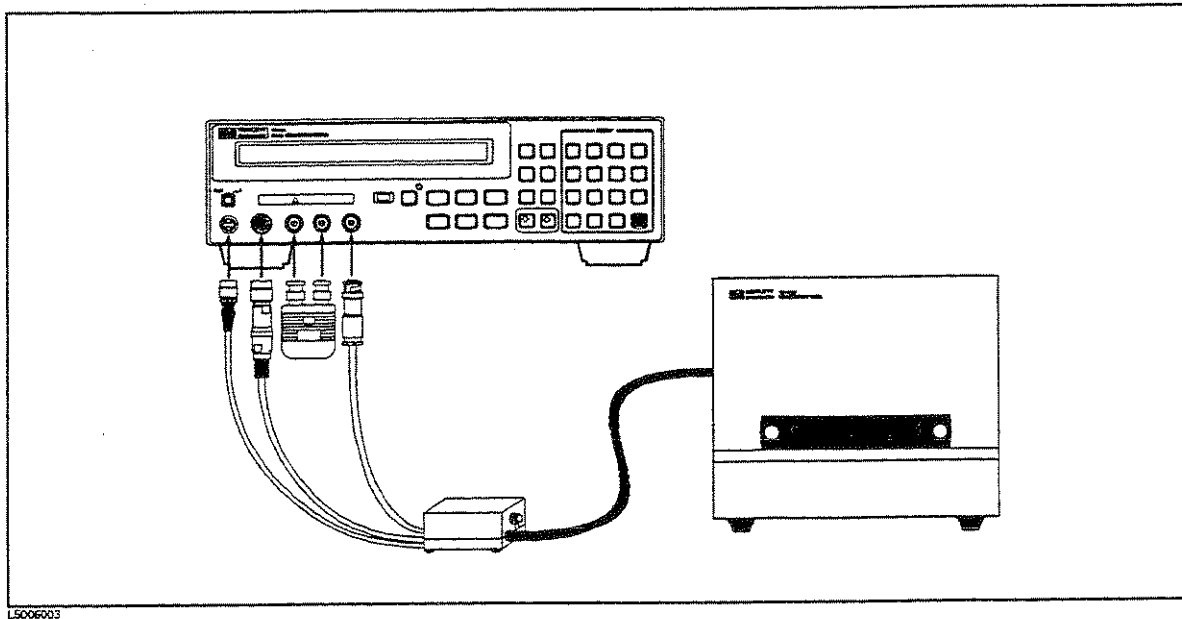







Figure 6-4. Measurement Configuration

2. Reset the HP 4339A





Press   to select the reset menu. Press  to select YES, then press .

3. Set the source voltage value.

Press . Enter the voltage value, for example 500 (V). Press .

4. Perform calibration.

Press  .

5. Perform an OPEN correction.
 - a. Turn the load knob counterclockwise until the upper electrode does not move.
 - b. Close the top cover.
 - c. Select the Current measurement mode by pressing . (I is displayed on left end of the display).
 - d. Apply the source voltage by pressing .
 - e. Wait until the current has stabled to within 0.5 pA. (Displayed I value do not change by more than 0.5 pA.)
 - f. Start an OPEN correction by pressing  .
6. Place the DUT on the electrode of resistivity cell. Set the upper electrode into position.

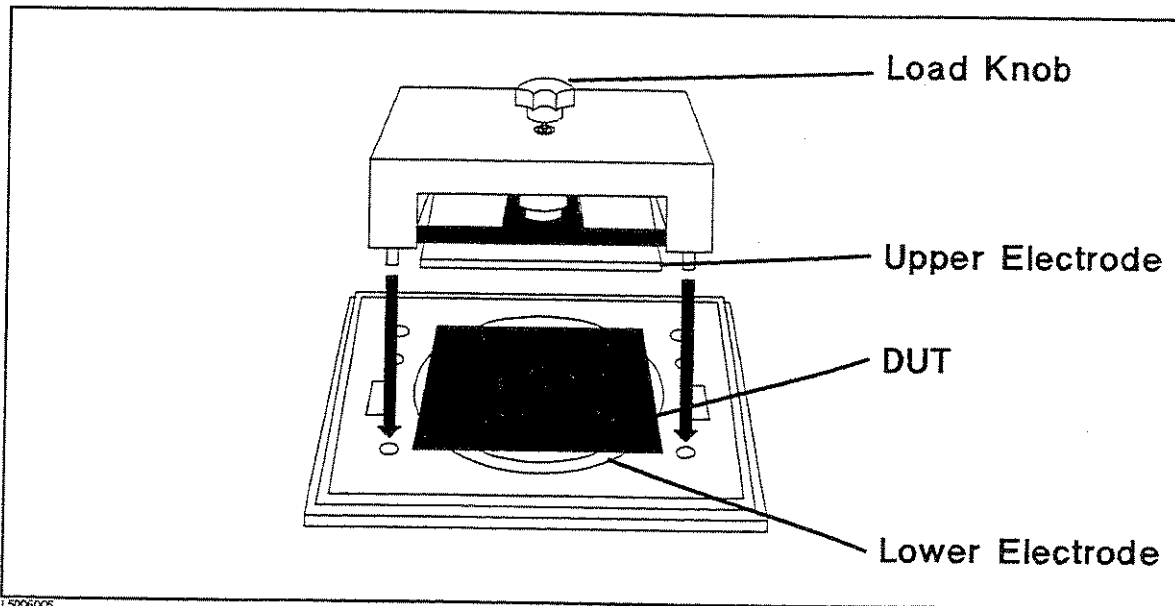

Figure 6-5. Resistivity Cell Setup

7. Turn the load knob to apply pressure by the upper and lower electrodes on the DUT, and then close the top cover.



Turning load knob applies load pressure on the DUT of up to approximately 10 kg. If you do not need to apply a specific pressure, DUT must at least firmly held by the upper and lower electrodes.

8. Set the resistivity cell parameter

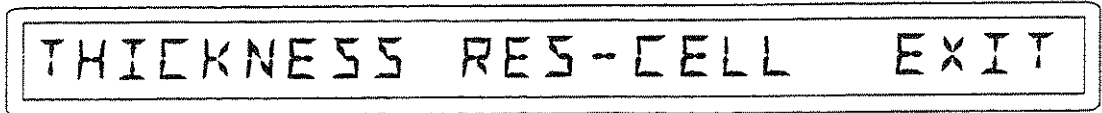
a. Press  .





b. Enter DUT thickness.

When THICKNESS is blinking, press . Enter the thickness value, for example 0.13 (mm). Press .

c. Select the resistivity cell size.

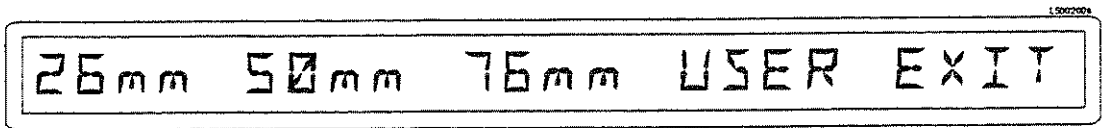



Select RES-CELL using  or , then press .



Select 50mm, then press .

d. Press  to exit.

9. Set the measurement sequence configuration.

Press  . Select CHARGE and press . Enter the charge time, for example 60 (s), then press  twice.

10. Select the single mode as the measurement sequence mode.

Press  until the Sgl annunciator is ON.

11. Measuring the volume resistivity.

a. Turn the Volume/Surface selector of the HP 16008B to "Volume".

b. Press  until RV is displayed on left end of the display.

c. Press .

This starts the volume resistivity measurement sequence. Measured volume resistivity value will be displayed after 60 seconds charge time.

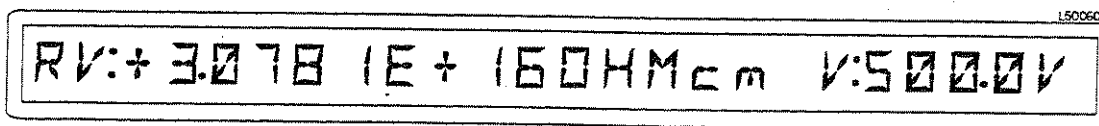



Figure 6-6. Volume Resistivity Result

Note

If you want to abort the measurement sequence, press  .



12. Measuring surface resistivity.

- a. Turn the Volume/Surface selector to "Surface".

The HP 4339A automatically displays RS on the left side of interlocking.

- b. Press .

This starts the surface resistivity measurement sequence. Measured surface resistivity value will be displayed after 60 seconds charge time.

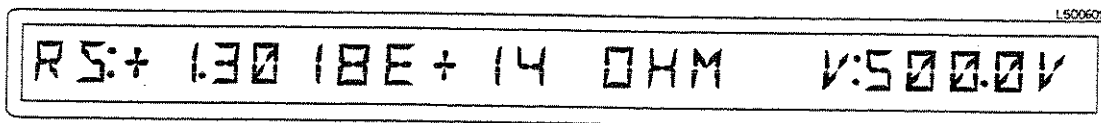





Figure 6-7. Surface Resistivity Result

Note

If you want to abort the measurement sequence, press  .



- 13. To exit the measurement sequence, press  twice.

The Sequence annunciator turns OFF and the measurement sequence stops.

- 14. Wait until the High Voltage indicator is OFF. Then remove the DUT from the test fixture.

Measuring Insulation Resistance Time Characteristics of Electro-Mechanical Components

This section provides an example of measuring electro-mechanical components like switches, connectors, or relays. This example measures insulation resistance (IR) time characteristics of opened switch contacts using the continuous measurement sequence mode, to obtain time characteristics.

In this example, we measure the insulation resistance of opened switch DUT, and print measurement data to printer. We take a measurement every 10 seconds for 10 minutes after a charge time of 60 seconds.

Warning



Do **NOT** touch the UNKNOWN terminals or the electrodes of the accessory, when the High Voltage indicator is ON, the HP 4339A outputs dangerous voltage levels up to 1000 Vdc. Before handling the HP 4339A or the accessory, turn OFF the test voltage pressing  and confirm that the High Voltage indicator is OFF.

1. Connect the shunt connector and the HP 16339A to the HP 4339A, and connect the printer using an HP-IB cable. (For the HP 16339A, use the Alligator Clip and Flat Table Configuration as shown in the *HP 16339A Operation and Service Manual*.)

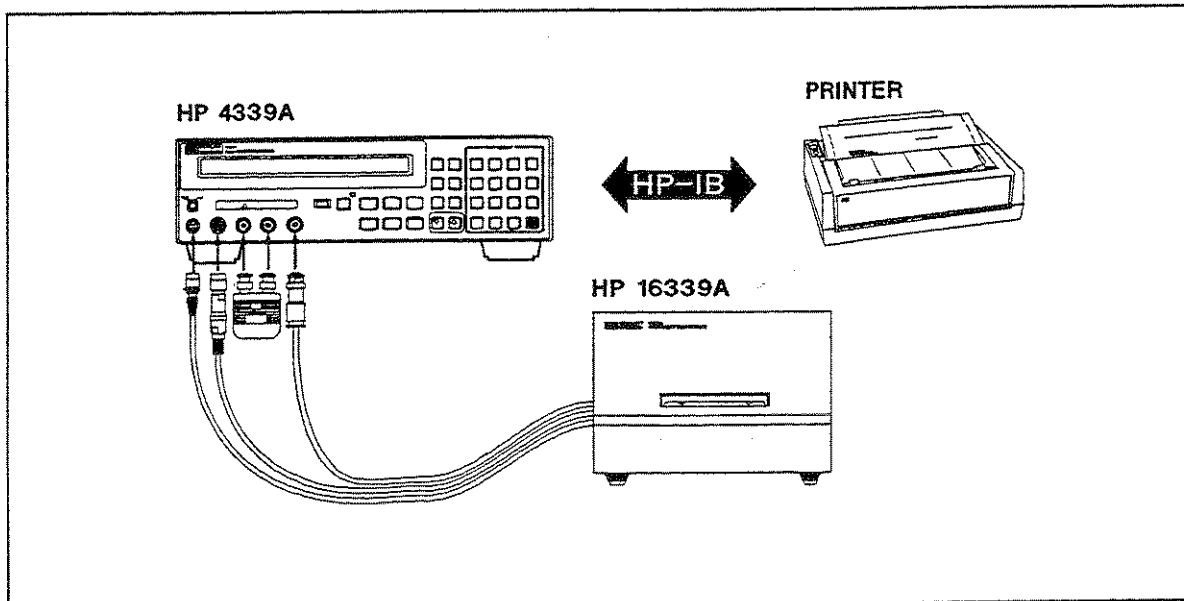







Figure 6-8. Measurement Configuration

2. Set the printer to the "listen always" mode.
3. Reset the HP 4339A

Press   to select the reset menu. Press  to select YES, then press .

4. Set the test voltage value.

Press . Enter the voltage value, for example 500 (V), Press .

5. Perform the calibration.

Press  .

6. Perform an OPEN correction.



a. Remove the alligator clips and banana cables from the INPUT terminal.

b. Close the top cover.

c. Select the current measurement mode by pressing  (I is displayed on left end of the display).

d. Apply test voltage by pressing .

e. Wait until the current has stabled to within 0.5 pA. (Displayed I value do not change by more than 0.5 pA.)

f. Start the OPEN correction by pressing  .

7. Connect the electrodes of the *opened* switch DUT with alligator clips as shown below. Close the cover of the HP 16339A.

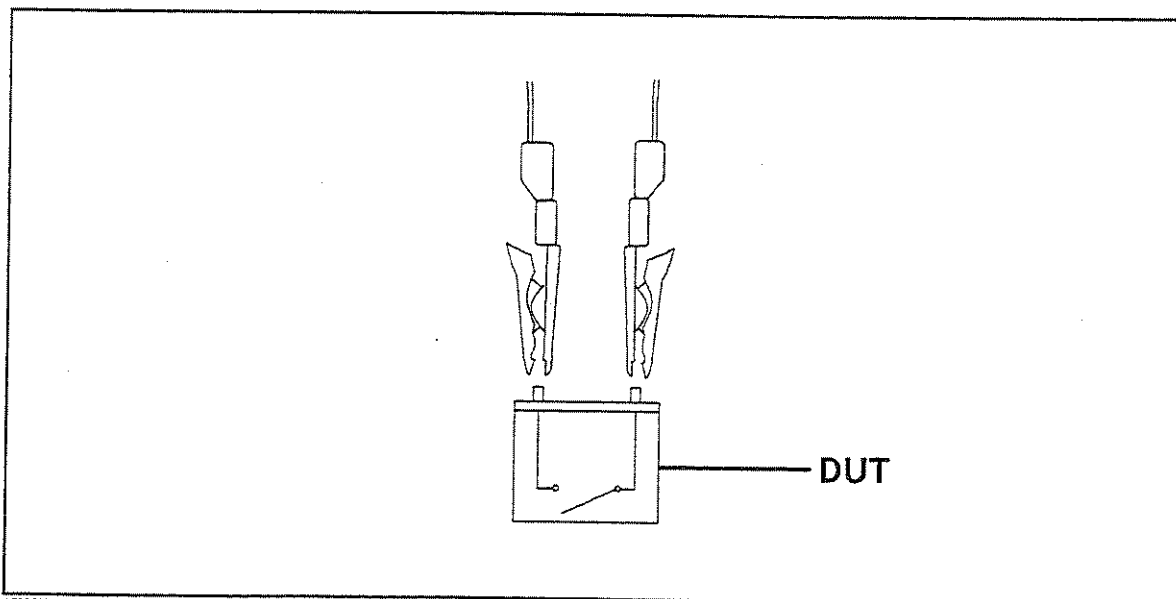



Figure 6-9. Clipping Opened Switch

8. Select Resistance as the measurement parameter.

Press  until R is displayed on left end of the display.

9. Set sequence mode parameters.

Press  .

a. Set the charge delay time.

Select CHRG. Enter the charge time value, in this example 60 (s). Press .

b. Set the measurement interval time.

Select INTVL. Enter the interval time value, in this example 10 (s). Press .



c. Set the number of measurements.

Select MEMORY. Enter the number of measurements, in this example 60. Press .

d. Select the continuous mode as the measurement sequence mode.

Press  until the Cont annunciator is displayed on the display.

10. Set the HP 4339A to Talk Only mode.



Press   and enter 31. Press .

11. Start the measurement sequence.

Press . The printer begins printing data.

```
+0,+6.51404E+10,+0
+0,+6.63321E+10,+0
+0,+6.45753E+10,+0
:
```

Figure 6-10. Printed Results

Note If you want to abort the measurement sequence, press  .



12. When the measurement sequence is completed, change the HP-IB address to an address other than 31.

13. Wait until the High Voltage indicator is OFF. Then remove the DUT from the test fixture.

Handwritten text, likely bleed-through from the reverse side of the page. The text is extremely faint and difficult to decipher, but appears to be organized into a list or series of entries.

Measurement Basics

Introduction

This chapter provides information that will help you to work with your HP 4339A more effectively.

- Insulation Resistance Measurement
- Resistivity
- High capacitance DUT Measurement

Insulation Resistance Measurement

Residual Charge Effect

Once a high resistance insulation material is charged with a voltage, a residual voltage will still remain on the material for a while after the charging voltage is removed. When you want to measure a high resistance material after charging and measuring it once, you must wait long enough to discharge the voltage across DUT from the previous measurement before making another measurement, or the measurement value may be incorrect.

Absorption Phenomena

When a high resistance insulation material remains charged with a voltage for a long time, its resistance value will increase. So record the time from which the charge was applied to the DUT to the start of the measurement.

Voltage Coefficient and Temperature Coefficient

The resistance value of an insulation material depends on the measurement voltage: the resistance value of most insulation materials will increase as the measurement voltage increases.

The resistance of an insulation material depends on its temperature. To measure accurately, place the DUT into an environmental test chamber to keep the DUT's temperature at a constant known level when making a measurement.

Record the measurement voltage and temperature when making a measurement.

Shielding

Variation in total current seen by the measurement circuit can be caused by power-line noise pickup, adjacent electro-magnetic fields of excessive strength, flexing the test leads beyond reasonable limits, or by changing the position of the leads relative to their surroundings. Most noise problems of this type are transient, and contribute more inconvenience than error. Any suitable enclosure will suffice to reduce unwanted noise pick-up. Connect the shield to the guard (ground). When using sensitive measurement ranges, lead movement or operator proximity will affect the stability of the measurement. Stationary leads and shielding are recommended.

Resistivity

Volume Resistivity

In general, volume resistivity is defined as the resistance per unit volume.

$$\rho_v = \frac{Area}{t} R_v$$

where,

- ρ_v Volume resistivity [Ω -mm]
- Area Effective area [mm^2]
- t Thickness of the sample [mm]
- R_v Measured volume resistance [Ω]

When the HP 16008B Resistivity Cell is used, the above equation becomes:

$$\rho_v = \frac{\pi \times \left(D_1 + \frac{B(D_2 - D_1)}{2} \right)^2}{4t} \times R_v$$

Where,

- D_1 Main electrode diameter [mm]
- D_2 Guard electrode diameter [mm]
- B Effective area coefficient

B is the fraction of the gap width to be added to the diameter of the circular electrodes or to the dimensions of rectangular or cylindrical electrodes. The value is usually specified by the standard that you use. (For example: 1 for ASTM D 257; 0 for JIS K6911).

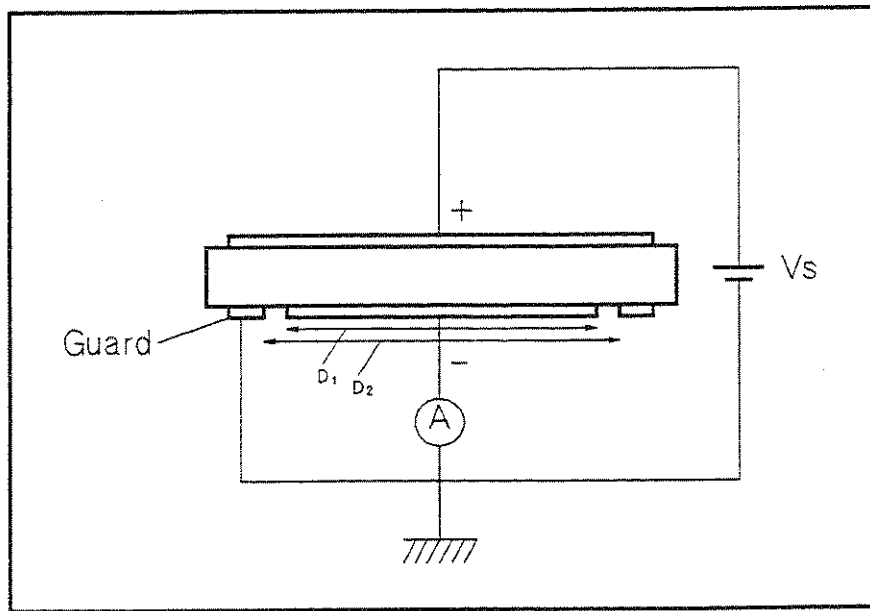

Figure 7-1. Volume Resistivity

Surface Resistivity

Surface Resistivity is defined as resistance per unit surface area. Similar to volume resistivity, surface resistivity is the resistance of a square of a material whose side length is 1 m, (one square meter). Surface resistivity is given as:

$$\rho_s = \frac{\text{Perimeter}}{\text{Gap}} R_s$$

where,

ρ_s	Surface resistivity [Ω]
<i>Perimeter</i>	Effective perimeter [mm]
<i>Gap</i>	Gap between main and guard electrodes [mm]
R_s	Measured surface resistance [Ω]

When the HP 16008B Resistivity Cell is used, the equations above become:

$$\rho_s = \frac{\pi(D_1 + D_2)}{D_2 - D_1} R_s$$

D_1	Main electrode diameter [mm]
D_2	Guard electrode diameter [mm]

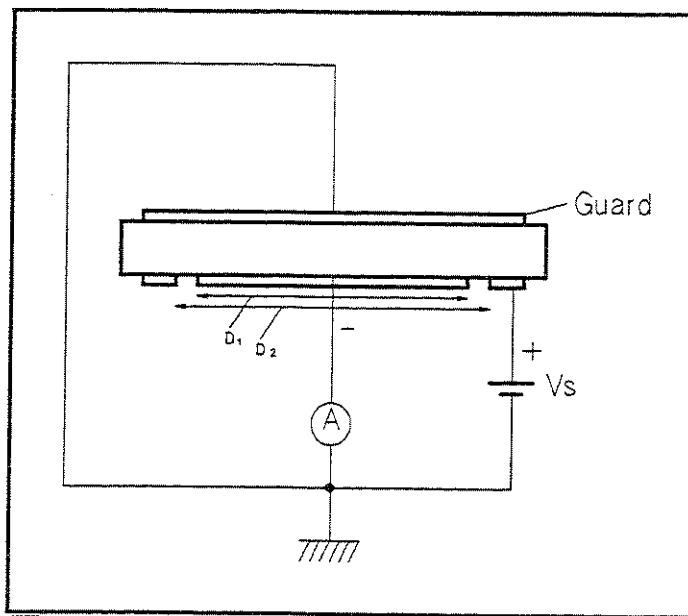

Figure 7-2. Surface Resistivity

High Capacitance DUT Measurement

When the HP 4339A measures a DUT that has high capacitance, AC noise creates major instability factors in the measurement because capacitance is sensitive to AC noise. If you want to measure the resistance of a high-capacitance DUT maintaining more than 10 % of S/N (Signal/Noise) ratio, the maximum capacitance of the DUT's for each measurement range are listed in Table 7-1.

Table 7-1. Maximum Measurable Capacitance

Measurement Range	Measurement Time		
	Short	Medium	Long
100 pA	—	1 nF	10 nF
1 nA	1 nF	10 nF	100 nF
10 nA	10 nF	100 nF	1 μ F
100 nA	100 nF	1 μ F	10 μ F
1 μ A	1 μ F	10 μ F	100 μ F
10 μ A	10 μ F	100 μ F	1 mF
100 μ A	100 μ F	—	—

To measure a DUT with even higher capacitance, connect a resistor in series with DUT to reduce the measurement flicker. The HP 16339A Component Test Fixture with its exchangeable output resistors is an ideal solution for this application. The HP 16339A has four output resistor (100 k Ω , 1 M Ω , 10 M Ω , and 100 M Ω). Ideally, a higher series resistance enables more stable measurement. However, there are limitations to these resistances of each measurement range, as listed in Table 7-2.

Table 7-2. Limit Output Resistance for Each Range

Measurement Range	Output Resistor
100 pA	100 M Ω
1 nA	10 M Ω
10 nA	1 M Ω
\geq 100 nA	100 k Ω

In addition, Table 7-3 shows the appropriate resistor for each range and measurement time mode.

Table 7-3. Appropriate Output Resistance for Range

Measurement Range	Measurement Time Mode		
	Short	Medium	Long
100 pA	—	10 M Ω (100 M Ω ¹)	10 M Ω (100 M Ω ¹)
1 nA	10 M Ω	1 M Ω	1 M Ω
10 nA	1 M Ω	100 k Ω	100 k Ω
100 nA	100 k Ω	(100 k Ω) ²	(100 k Ω) ²
1 μ A	(100 k Ω) ²	Short Bar ³	Short Bar ³
10 μ A	Short Bar ³	Short Bar ³	Short Bar ³
100 μ A	Short Bar ³	—	—

1 100 M Ω resistor is effective for measuring current less than 10 pA in 100 pA range.

2 Using 100 k Ω resistor is recommended, but the response will become slow.

3 HP 4339A's internal input and output resistance are sufficient, so an extra resistor in series is not necessary, in this range and mode.

Note



Using a high resistance in series with the DUT causes the charging time constant to increase, thereby increasing the necessary measurement time.

Warning



Do **NOT** touch the electrode and UNKNOWN connector while the High Voltage indicator is lit which shows the HP 4339A's output is a high voltage levels up to 1000 Vdc maximum. You must operate after turning off the voltage source output and you have confirmed the high voltage indicator is turned off.

Figure 7-3 shows the measurement configuration for this application.

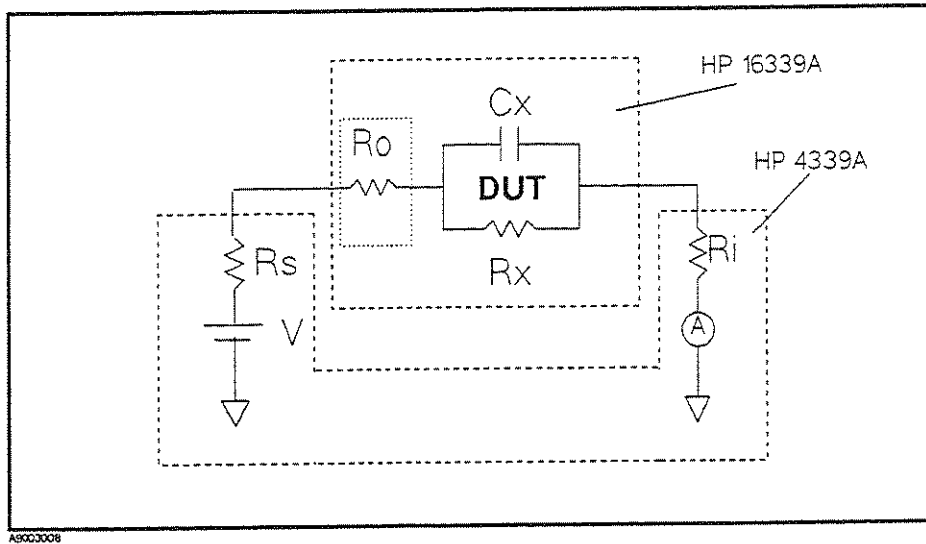

Figure 7-3. Capacitance Measurement Configuration

Where,

- Rs Output Resistance of the HP 4339A
- Rx Parallel resistance of the DUT
- Cx Parallel capacitance of the DUT
- Ri Input resistance of the HP 4339A
- Ro Additional Series Output Resistance of the HP 16339A

Necessary charging time is approximately led by following equation.

$$t_c = -\tau \times \ln\left(\frac{X}{100} \times \frac{R_s + R_i + R_o}{R_x}\right)$$

Where,

- t_c : Charge time [s]
- X : Measurement Error [%]
- $\tau = C_x \times (R_s + R_i + R_o)$

Generally, when measuring these types of DUT's as described in this section, you should expect a charging time of more than 10 or 20 times τ .

Note

When the additional series resistor value is too high, its resistance can not be disregarded and it causes additional measurement error.



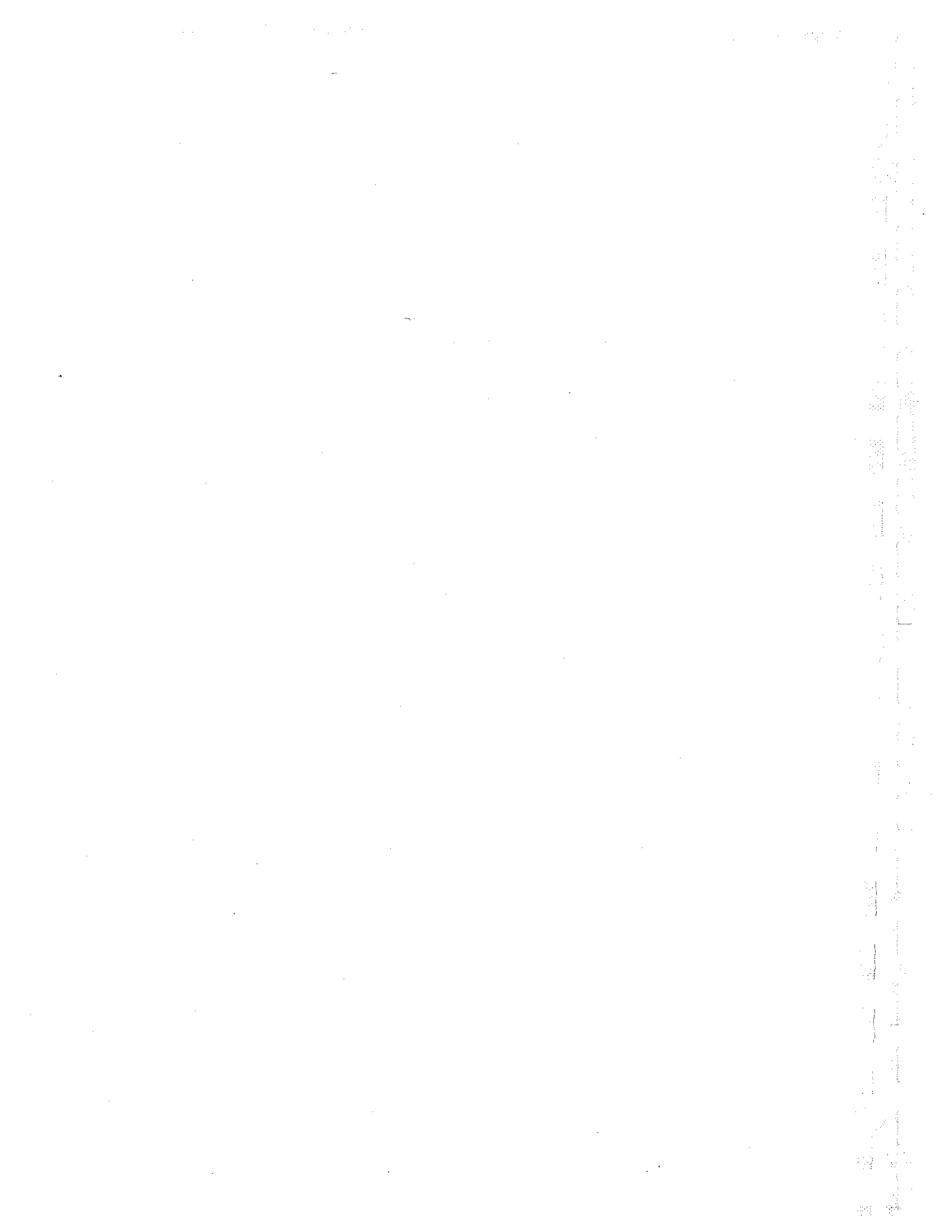

Specifications

This chapter contains a list of specifications for reference and performance verifications. When shipped from the factory, the HP 4339A meets the specifications listed in this chapter.

This chapter also includes supplemental characteristics. These characteristics are not specifications but are typical characteristics included as supplemental information for the operator.

Specifications

These specifications are the performance standards or limits against which the instrument is tested. When shipped from the factory, the HP 4339A meets the specifications listed in this section. The specification test procedures are covered in Chapter 9.

Measurement Parameters

R (dc resistance), I (dc current), ρ_s (surface resistivity), ρ_v (volume resistivity)

Measurement Conditions

DC Test Voltage (V_s)

■ Range

0 to 1000 V, 0.1 V steps for $V_s \leq 200$ V or 1.0 V steps for $V_s > 200$ V

■ Accuracy

$\pm (0.16\% + 100 \text{ mV})$ for $V_s \leq 200$ V

$\pm (0.16\% + 500 \text{ mV})$ for $V_s > 200$ V

■ Maximum Current

10 mA for $V_s \leq 100$ V

5 mA for $V_s \leq 250$ V

2 mA for $V_s \leq 500$ V

1 mA for $V_s > 500$ V

■ Current Compliance Setting

0.5 mA, 1 mA, 2 mA, 5 mA, 10 mA

Ammeter

■ Input Resistance

1 k Ω \pm 5%

■ Input Offset Voltage

$\leq \pm 500 \mu\text{V}$

Test Cable Length

2 meters maximum

Measurement Time Mode

Short, Medium, and Long

Ranging

Auto and Hold (manual)

Averaging

1 to 256

HP 4339A

Specifications

Trigger Mode

Internal, Manual, External, and Bus

Trigger Delay Time

0 to 9.999 seconds in 0.001 seconds steps

Measurement Range

- R: 1×10^3 to $1.6 \times 10^{16} \Omega$
- I: 60 fA to $100 \mu\text{A}$

Measurement Accuracy

The following conditions must be met for measurement accuracy to apply:

1. Warm up time: ≥ 30 min
2. Ambient temperature: 23 ± 5 °C
3. Offset-error canceling is ON.
4. OPEN correction has been performed.
5. Self calibration has been performed.

Table 8-1. Measurement Accuracy

Range	Measurement Time Mode	Resistance Measurement ^{1,2,3} ±(% of Readings)	Current Measurement ^{2,3,4} ±(% of Readings)
100 pA	Short	—	—
	Medium	$4.4 + \left(\frac{100V_o + 100 \times 10^{-12} R_m}{V_s}\right)$ [$4.4 + \left(\frac{100V_o + 110 \times 10^{-12} R_m}{V_s}\right)$] ⁵	$2.57 + \left(\frac{100 \times 10^{-12}}{I_m}\right)$ [$2.57 + \left(\frac{110 \times 10^{-12}}{I_m}\right)$] ⁵
	Long ⁶	$4.4 + \left(\frac{100V_o + 6 \times 10^{-12} R_m}{V_s}\right)$ ⁷ [$4.4 + \left(\frac{100V_o + 5 \times 10^{-11} R_m}{V_s}\right)$] ^{7,8} [$4.4 + \left(\frac{100V_o + 8 \times 10^{-12} R_m}{V_s}\right)$] ^{5,7}	$2.57 + \left(\frac{6 \times 10^{-12}}{I_m}\right)$ ⁷ [$2.57 + \left(\frac{5 \times 10^{-11}}{I_m}\right)$] ^{7,8} [$2.57 + \left(\frac{8 \times 10^{-12}}{I_m}\right)$] ^{5,7}
1 nA	Short	$4.4 + \left(\frac{100V_o + 100 \times 10^{-11} R_m}{V_s}\right)$	$1.12 + \left(\frac{100 \times 10^{-11}}{I_m}\right)$
	Medium	$4.4 + \left(\frac{100V_o + 20 \times 10^{-11} R_m}{V_s}\right)$	$1 + \left(\frac{20 \times 10^{-11}}{I_m}\right)$
	Long	$4.4 + \left(\frac{100V_o + 3 \times 10^{-11} R_m}{V_s}\right)$ ⁷ [$4.4 + \left(\frac{100V_o + 5 \times 10^{-11} R_m}{V_s}\right)$] ^{7,8}	$0.91 + \left(\frac{3 \times 10^{-11}}{I_m}\right)$ ⁷ [$0.91 + \left(\frac{5 \times 10^{-11}}{I_m}\right)$] ^{7,8}

1 Rm: Measured resistance value [Ω].

Vs: Voltage setting [V].

Vo: 0.1 [V] (Vs ≤ 200 V) or 0.5 [V] (Vs > 200 V)

2 When the temperature (T) range is 20±5°C.

Multiply both the first term and the second term (the value in parenthesis) by the following error factors when the measurement time mode is set to SHORT or MEDIUM, or multiply only the first term by one of the following error factors when the measurement time mode is set to LONG,

8 ≤ T < 18 °C, or 28 < T ≤ 38 °C : ×2

0 ≤ T < 8 °C, or 38 < T ≤ 55 °C : ×4

Multiply the second term (the value in parenthesis) by the following error factors when the measurement time mode is set to LONG,

8 ≤ T < 18 °C, or 28 < T ≤ 38 °C : ×5

0 ≤ T < 8 °C, or 38 < T ≤ 55 °C : ×25

3 When measuring a grounded DUT, multiply the second term (the value in parenthesis) by one of the following error factors according to the measurement time mode:

SHORT : ×2

MEDIUM : ×1.5

LONG : ×1.25

4 Im: Measured current value [A]

5 When the test cable length is 1.5 to 2 m.

6 After 1 second from range changing.

7 When the contact check function is ON, multiply the second term (the value in parenthesis) by 1.5.

8 When the Offset-Error Canceling is OFF.

Table 8-1. Measurement Accuracy (continued)

Range	Measurement Time Mode	Resistance Measurement ^{1,2,3} ±(% of Readings)	Current Measurement ^{2,3,4} ±(% of Readings)
10 nA	Short	$2.6 + \left(\frac{100V_o + 20 \times 10^{-10} R_m}{V_s}\right)$	$0.67 + \left(\frac{20 \times 10^{-10}}{I_m}\right)$
	Medium	$2.6 + \left(\frac{100V_o + 7 \times 10^{-10} R_m}{V_s}\right)$	$0.6 + \left(\frac{7 \times 10^{-10}}{I_m}\right)$
	Long	$2.6 + \left(\frac{100V_o + 2.5 \times 10^{-10} R_m}{V_s}\right)^7$	$0.6 + \left(\frac{2.5 \times 10^{-10}}{I_m}\right)^7$
100 nA	Short	$0.8 + \left(\frac{100V_o + 13 \times 10^{-9} R_m}{V_s}\right)$	$0.62 + \left(\frac{13 \times 10^{-9}}{I_m}\right)$
	Medium	$0.8 + \left(\frac{100V_o + 6.5 \times 10^{-9} R_m}{V_s}\right)$	$0.5 + \left(\frac{6.5 \times 10^{-9}}{I_m}\right)$
	Long	$0.8 + \left(\frac{100V_o + 2.5 \times 10^{-9} R_m}{V_s}\right)^7$	$0.5 + \left(\frac{2.5 \times 10^{-9}}{I_m}\right)^7$
1 μA	Short	$0.77 + \left(\frac{100V_o + 13 \times 10^{-8} R_m}{V_s}\right)$	$0.61 + \left(\frac{13 \times 10^{-8}}{I_m}\right)$
	Medium	$0.65 + \left(\frac{100V_o + 6.5 \times 10^{-8} R_m}{V_s}\right)$	$0.49 + \left(\frac{6.5 \times 10^{-8}}{I_m}\right)$
	Long	$0.6 + \left(\frac{100V_o + 2.5 \times 10^{-8} R_m}{V_s}\right)^7$	$0.4 + \left(\frac{2.5 \times 10^{-8}}{I_m}\right)^7$
10 μA	Short	$0.7 + \left(\frac{100V_o + 13 \times 10^{-7} R_m}{V_s}\right)$	$0.54 + \left(\frac{13 \times 10^{-7}}{I_m}\right)$
	Medium	$0.58 + \left(\frac{100V_o + 6.5 \times 10^{-7} R_m}{V_s}\right)$	$0.42 + \left(\frac{6.5 \times 10^{-7}}{I_m}\right)$
	Long	$0.5 + \left(\frac{100V_o + 2.5 \times 10^{-7} R_m}{V_s}\right)^7$	$0.33 + \left(\frac{2.5 \times 10^{-7}}{I_m}\right)^7$
100 μA	Short	$0.68 + \left(\frac{100V_o + 7.5 \times 10^{-6} R_m}{V_s}\right)$	$0.52 + \left(\frac{7.5 \times 10^{-6}}{I_m}\right)$
	Medium	—	—
	Long	—	—

8 Specifications

Measurement Support Functions

Display

24-digit LCD display. Capable of displaying: measurement values, comparator/contact check decisions, comparator limits, control settings, self test messages, and annunciators

Correction

■ **Zero OPEN:**

Eliminates measurement errors due to stray capacitance in the test cable and residual resistance in the test fixture.

■ **Self calibration:**

Calibrates the instrument offset errors due to the change of ambient temperature.

Test Sequence Program:

Controls a series of measurements (charge-measure-discharge). Charge time, measurement interval time, and the number of measurements can be programmed.

Mathematical Functions

The deviation and the percent deviation of measurement values from a programmable reference value can be displayed.

Comparator

HIGH/IN/LOW for the measurement parameter.

Contact Check

Contact failure between the test fixture and device can be detected.

Available DUT type: Capacitive DUT only

HP-IB Interface

All control settings, measurement values, self-test results, and comparator information can be controlled or monitored via HP-IB.

Handler Interface

All output signals are negative logic, opto-isolated, open collector outputs.

■ **Output Signals Include:**

HIGH/IN/LOW and no contact, index, end-of-measurement, and alarm.

■ **Input Signals Include:**

High voltage OFF, keylock, and External trigger

Save/Recall

Ten instrument setups can be saved and recalled from the internal non-volatile memory.

Continuous Memory Capability

If the instrument is turned OFF, or if a power failure occurs, the instrument settings are automatically saved.

Key Lock

Disables key input from the front panel.

General

Power Requirements

100/120/220/240 V $\pm 10\%$, 47 to 66 Hz
45 VA max

Operating Temperature and Humidity

0 to 55 °C, $\leq 95\%$ RH @ 40 °C
Condensation must be avoided.

Storage Temperature and Humidity

-40 °C to 70 °C, $\leq 95\%$ RH @ 40 °C
Condensation must be avoided.

Dimensions

approximately 320 (W) by 100 (H) by 450 (D) mm

Weight

approximately 6.5 kg

Supplemental Performance Characteristics

The supplemental performance characteristics are listed below. These characteristics are not specifications but are typical characteristics included as additional information for the operator.

Typical Measurement Accuracy

Range	Resistance Measurement (\pm % of Readings) ¹	Current Measurement (\pm % of Readings) ²
100 pA	$0.86 + \left(\frac{100V_o + 6 \times 10^{-12} R_m}{V_s}\right)$	$0.7 + \left(\frac{6 \times 10^{-12}}{I_m}\right)$
1 nA	$0.74 + \left(\frac{100V_o + 3 \times 10^{-11} R_m}{V_s}\right)$	$0.58 + \left(\frac{3 \times 10^{-11}}{I_m}\right)$
10 nA	$0.56 + \left(\frac{100V_o + 2.5 \times 10^{-10} R_m}{V_s}\right)$	$0.4 + \left(\frac{2.5 \times 10^{-10}}{I_m}\right)$
100 nA	$0.53 + \left(\frac{100V_o + 2.5 \times 10^{-9} R_m}{V_s}\right)$	$0.37 + \left(\frac{2.5 \times 10^{-9}}{I_m}\right)$
1 μ A	$0.53 + \left(\frac{100V_o + 2.5 \times 10^{-8} R_m}{V_s}\right)$	$0.37 + \left(\frac{2.5 \times 10^{-8}}{I_m}\right)$

1 R_m : Measured resistance value [Ω]

V_s : Voltage setting [V]

V_o : 0.1 [V] ($V_s \leq 200$ V) or 0.5 [V] ($V_s > 200$ V)

2 I_m : Measured current value [A]

Measurement Time

The following table lists some typical measurement times.

Measurement Time Mode	Analog Measurement ¹ [ms]	Digital Computation [ms]	Total ^{1,2} [ms]
Short	8.5 (10.5)	1.5	10 (12)
Medium	28.5 (30.5)	1.5	30 (32)
Long	385 (387)	5	390 (392)

1 Numbers in parenthesis indicate the measurement times when a contact check is performed.

2 Time interval from a trigger command to EOM (end of measurement) signal output at the handler interface port.
(ranging: hold, display mode: off)

DC Test Voltage Settling

Slew rate until the output voltage reaches 90 % of the set voltage (Set V) is,

$$V'/t' = 10 \text{ V/ms}$$

Where V' and t' is shown in the following figure.

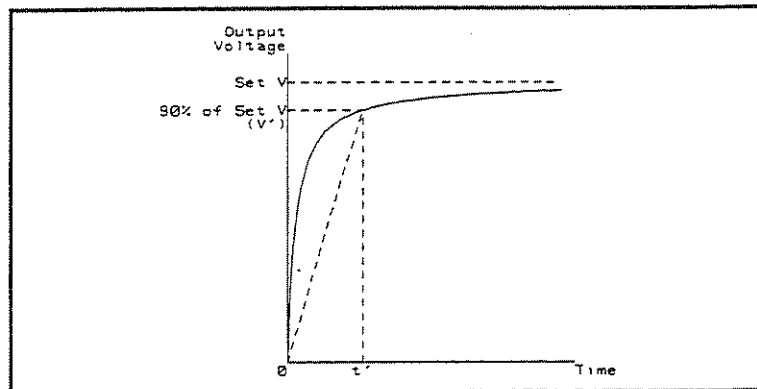

DC Test Voltage Output Resistance

$1 \text{ k}\Omega \pm 10\%$

Contact Check Required Conditions

- DUT capacitance: $\geq 0.5 \text{ pF} + 5\%$ of residual stray capacitance
- Residual stray capacitance of the test fixture: $\leq 50 \text{ pF}$

Continuous Memory Duration

72 hours (@ $23 \pm 5 \text{ }^\circ\text{C}$)

Safety Considerations

The HP 4339A conforms to the following safety requirements and is shipped from the factory in a safe condition.

- International Electrotechnical Commission (IEC) Publication-348 (1978) Safety Class 1
- Canadian Standards Association (CSA) - C22.2 No. 231
- Underwriters' Laboratories (UL) - 1244

Faint, illegible text or markings along the right edge of the page, possibly bleed-through from the reverse side.

Maintenance

Introduction

This chapter provides information on how to maintain the HP 4339A. HP 4339A maintenance consists of performance tests and functional tests.

Test Equipment

Table 9-1 lists the recommended equipment for performing HP 4339A maintenance.

Table 9-1. Required Equipment

Equipment	Requirements	Recommended Model	Qty.	Use ¹
DC Voltmeter	Voltage Range: 0 V to 1000 V Accuracy: < 0.04%	HP 3458A	1	P
RC Box	No substitute	HP 16340A	1	P, F
RC Box Adapter	No substitute	PN 04339-65005	1	P, F
V Measurement Adapter	No Substitute	PN 04339-65006	1	P
Cable	Banana-Banana Jumper	HP 11058A	1	P
Cable	Dual Banana-BNC(m) Cable	PN 11001-60001	1	P
Handler Interface Tester	No Substitute	PN 04339-65007	1	F

¹ P: Performance Tests, F: Functional Tests

Performance Tests

Introduction

This section provides the test procedures used to verify that the HP 4339A's specifications listed in Chapter 8, General Information, of this manual are met. All tests can be performed without access to the interior of the instrument. The performance tests can also be used to perform incoming inspection, and to verify that the HP 4339A meets its performance specifications after troubleshooting or adjustment. If the performance tests indicate that the HP 4339A is NOT operating within the specified limits, check your test setup, then proceed with troubleshooting if necessary.

Note Allow the HP 4339A to warm up for at least 30 minutes before you execute any of the performance tests.



Note Perform all performance tests in ambient conditions of $23^{\circ}\text{C} \pm 5^{\circ}\text{C}$, $\leq 70\%$ RH.



Test Equipment

Table 9-1 lists the test equipment required to perform the tests described in this section. Use only calibrated test instruments when performance testing the HP 4339A. Equipment which equals or surpasses the key required specifications of the recommended equipment may be used as a substitute.

Calculation Sheet

The calculation sheet is used as an aid for recording raw measurement data, and for calculating the performance test results.

The performance test procedure gives the test sequence for performing a test. The complete set of measurement data is recorded on the calculation sheet. The results are calculated using the equations given on the calculation sheet, and the results are transcribed to the performance test record.

The procedure for using the calculation sheet is:

1. Photocopy the calculation sheet.
2. Follow the performance test procedure and record the measurement value(s), the HP 4339A's reading, etc., into the specified column on the calculation sheet.
3. Calculate the test result using the appropriate equation given on the calculation sheet, and record the test result into the Test Result column of the performance test record.

Performance Test Record

Record the performance test results in the test record at the end of this chapter (Photocopy the test record and use the photocopy). The test record lists all test specifications, their acceptable limits, and measurement uncertainties for the recommended test equipment. Test results recorded during incoming inspection can be used for comparison purposes during periodic maintenance, troubleshooting, and after repair or adjustment.

Calibration Cycle

The HP 4339A requires periodic performance tests. The frequency of performance testing depends on the operating and environmental conditions under which the HP 4339A is used. Verify the HP 4339A's performance at least once a year, using the performance tests described in this section.

Source Voltage Accuracy Test

The HP 4339A's source voltage is measured with a DC voltmeter.

Specification

Source Voltage (V_s) Accuracy: $\pm (0.16 \% + 100 \text{ mV}) (V_s \leq 200 \text{ V})$
 $\pm (0.16 \% + 500 \text{ mV}) (V_s > 200 \text{ V})$





Test Equipment

Description	Recommended Model
Multimeter	HP 3458A
V Measurement Adapter	PN 04339-65006
Banana-Banana Jumper	HP 11508A

Procedure

Warning When the High Voltage indicator is lit, the HP 4339A outputs high voltages of up to 1000 Vdc maximum.



1. Reset the HP 4339A using the following procedure:
 - a. Press   to display the system reset settings.
 - b. Press  until *YES* blinks, then press .
2. Set up the equipment as shown in Figure 9-1.

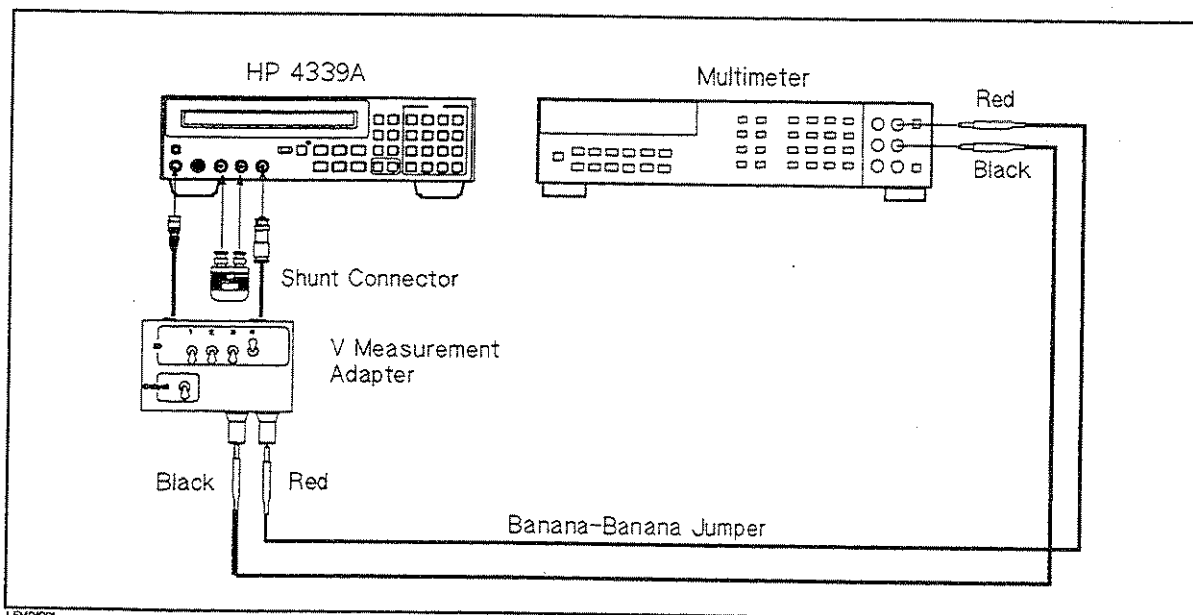

Figure 9-1. Source Voltage Accuracy Test Setup

3. Press the HP 3458A Multimeter's **DCV** to set the measurement mode to DC voltage.
4. Set the V Measurement Adapter's ID switches and Output switch as follows:

Switch	Setting
ID1	0
ID2	0
ID3	0
ID4	1
Output	Enable





5. On the HP 4339A, press  to turn the source voltage ON. (V Output indicator turns ON.)
6. Record the multimeter reading on the calculation sheet. (Initial output voltage setting is 0 V.)
7. Press  to turn the source voltage OFF. (V Output indicator turns OFF.)
8. Calculate the test result according to the calculation sheet, and record the result into the performance test record.
9. Perform this test for all the voltage settings listed in Table 9-2. The source voltage must be turned OFF after each test. The source voltage can be changed using the following procedure:
 - a. Press  to display the source voltage setting.
 - b. Use the numeric keys to enter a desired voltage, then press .
 - c. The desired voltage will be displayed.

Table 9-2. Source Voltage Accuracy Test Settings

Source Voltage Setting
0 V
10 V
25 V
50 V
100 V
200 V
201 V
250 V
500 V
1000 V

9 Maintenance

Ammeter Offset Voltage and Input Resistance Test

The HP 4339A's ammeter offset voltage and input resistance are measured.

Specification





Ammeter Offset Voltage:	$\leq 0.5 \text{ mV}$
Ammeter Input Resistance:	$1 \text{ k}\Omega \pm 5\%$

Test Equipment

Description	Recommended Model
Multimeter	HP 3458A
RC Box Adapter	PN 04339-65005
Dual Banana-BNC(m) Cable	PN 11001-60001

Procedure

Ammeter Offset Voltage Test.

- Reset the HP 4339A using the following procedure:
 - Press   to display the system reset settings.
 - Press  until *YES* blinks, then press .
- Set up the equipment as shown in Figure 9-2.

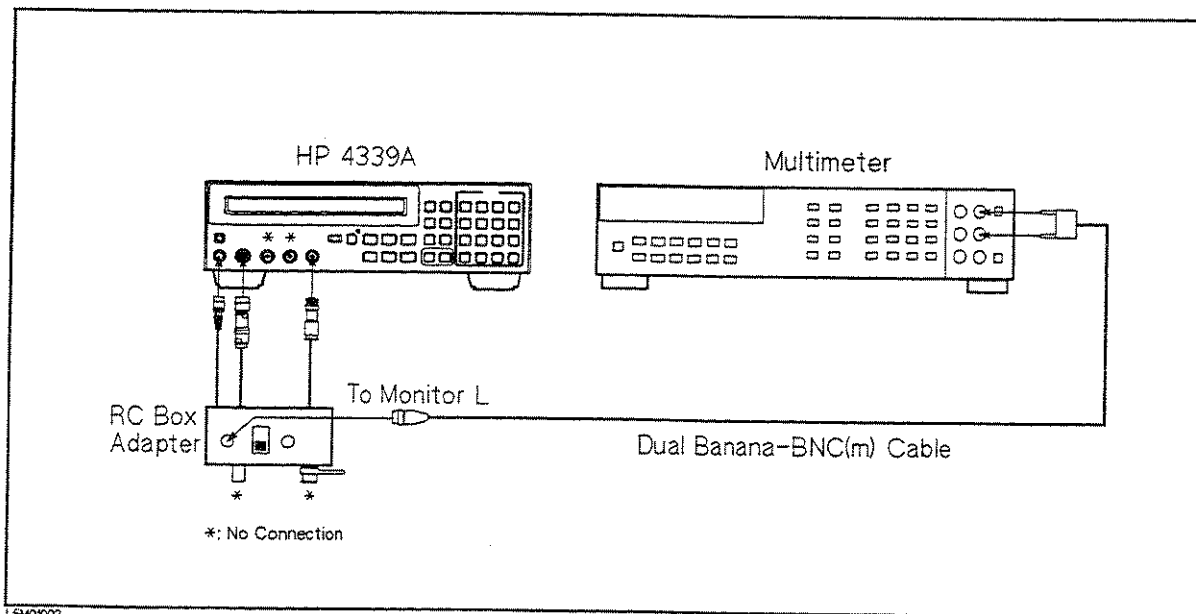

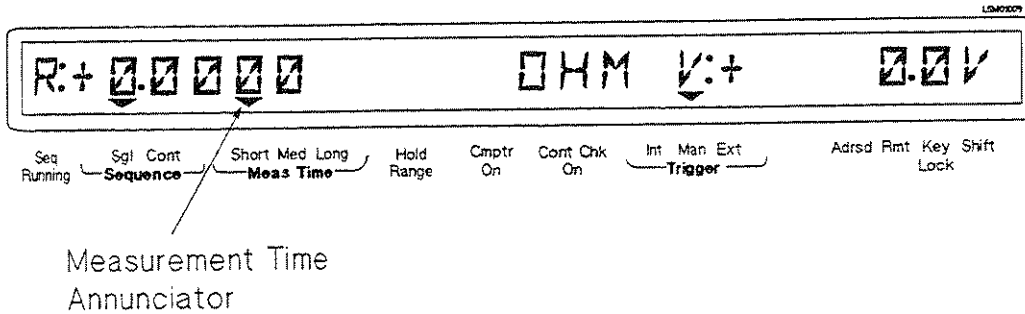





Figure 9-2. Ammeter Offset Voltage Test Setup

- Set the RC Box Adapter switch to the *F* position.
- Press the HP 3458A Multimeter's **DCV** to set the measurement mode to DC voltage.

5. Press the HP 4339A's  to set the measurement time to SHORT. The measurement time is displayed as follows:



6. Set the measurement range to 100 μ A using the following procedure:

- a. Press   to display the measurement range setting.
- b. Press  until 100 μ A appears, then press .

7. Press  to set the trigger mode to Manual. Trigger mode is displayed as follows:

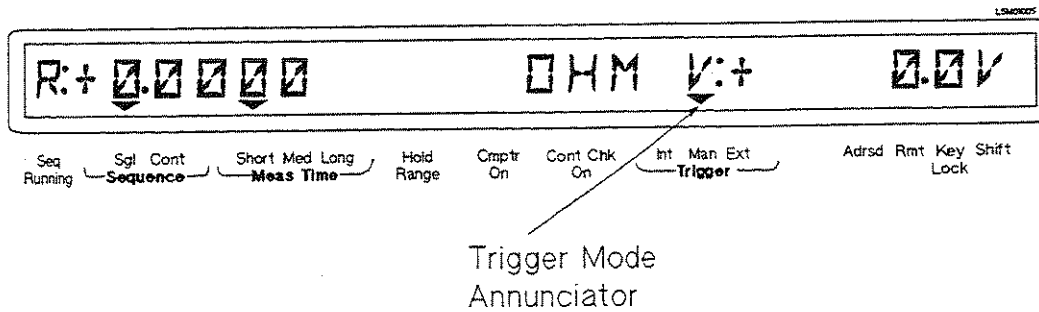

8. Record the multimeter reading into the performance test record. Don't change the equipment setup for the following ammeter input resistance test.

Ammeter Input Resistance Test.

9. Record the HP 16340A RC Box's 10⁴ Ω calibration value and the ammeter offset voltage test result on the calculation sheet.
10. Connect the RC Box to the RC Box adapter as shown in Figure 9-3.

9 Maintenance

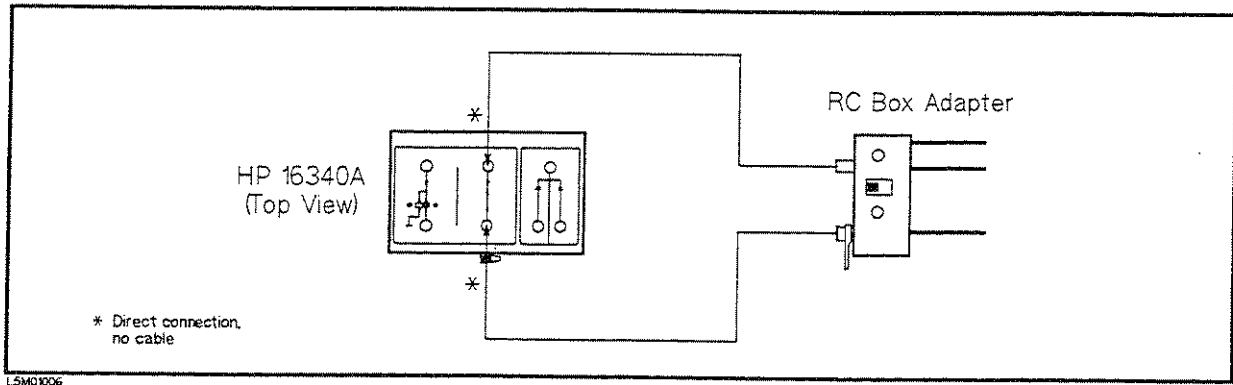





Figure 9-3. RC Box Connection

11. Set the RC Box resistor to $10^4 \Omega$.
12. Set the source voltage to 1 V using the following procedure:
 - a. Press  to display the source voltage setting.
 - b. Press   to set the source voltage to 1 V.
 - c. Confirm that + 1 V is displayed.
13. Press  to turn the source voltage ON. (V Output indicator turns ON.)
14. Record the multimeter reading on the calculation sheet on the L Voltage line.
15. Disconnect the Dual Banana-BNC(m) cable from the Monitor L terminal and connect it to the Monitor H terminal.
16. Record the multimeter reading on the calculation sheet on the H Voltage line.
17. Calculate the test result according to the calculation sheet, and record the result into the performance test record.

Current Measurement Accuracy Test

The HP 4339A measures the current through the calibrated RC Box, and the measured values are compared with the current values calculated from the RC box's calibration value and the voltage across the standard.











Specification

Basic Measurement Accuracy: $\pm 0.4 \%$ (See Chapter 8 General Information for details.)

Test Equipment

Description	Recommended Model
Multimeter	HP 3458A
RC Box	HP 16340A
RC Box Adapter	PN 04339-65005
Dual Banana-BNC(m) Cable	PN 11001-60001

Procedure

1. Record the HP 16340A RC Box calibration values on the calculation sheet.
2. Reset the HP 4339A using the following procedure:
 - a. Press   to display the system reset settings.
 - b. Press  until *YES* blinks, then press .
3. Set the Offset-error Canceling to ON using the following procedure:
 - a. Press   to display the configuration setting menu.
 - b. Press  until *OFST* blinks, then press .
 - c. Press  until *ON* blinks, then press  two times.
4. Set up the equipment as shown in Figure 9-4.

9 Maintenance

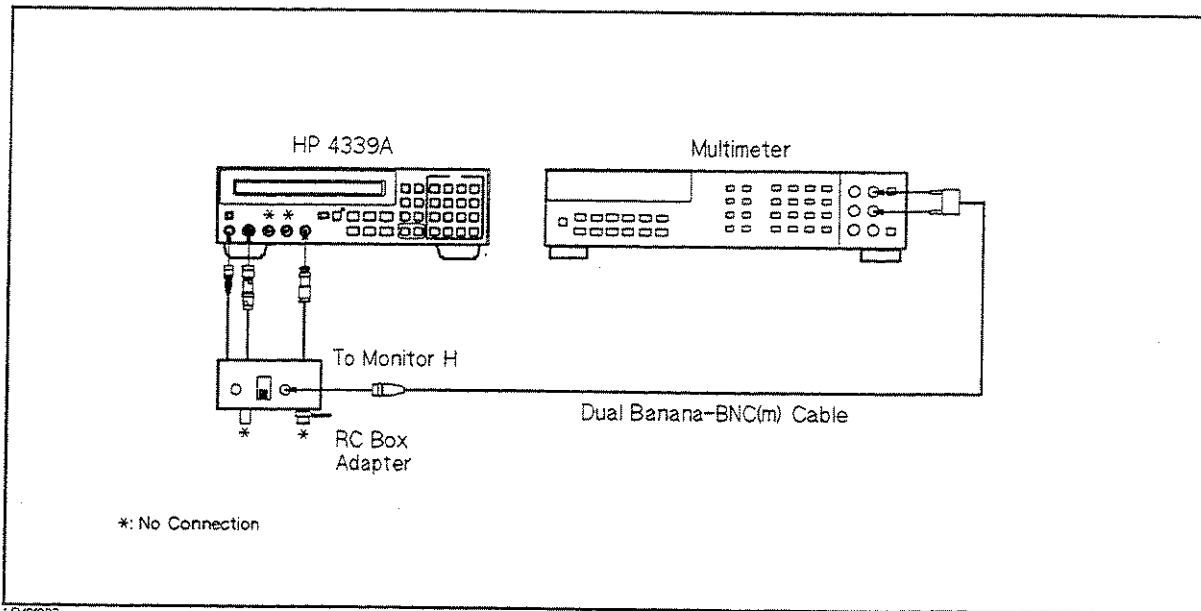











Figure 9-4. Current Measurement Accuracy Test Setup

5. Set the RC Box Adapter switch to the *F* position.
6. Press the HP 3458A Multimeter's **DCV** to set the measurement mode to DC voltage.
7. Press   **5** to perform the calibration.
8. Set the source voltage to 10 V using the following procedure:
 - a. Press  to display the source voltage setting.
 - b. Press  **1**  **0**  to set the source voltage to 10 V.
 - c. Confirm that +10 V is displayed.
9. Press  to turn the source voltage ON. (V Output indicator turns ON.)
10. Press   **4** to perform the open correction.
11. Press  to turn the source voltage OFF. (V Output indicator turns OFF.)
12. Connect the RC Box to the RC Box Adapter as shown in Figure 9-5.

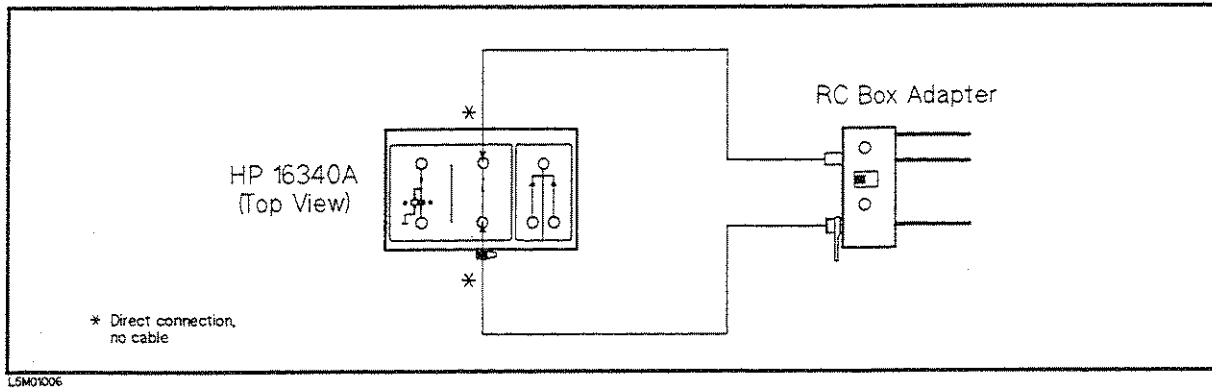
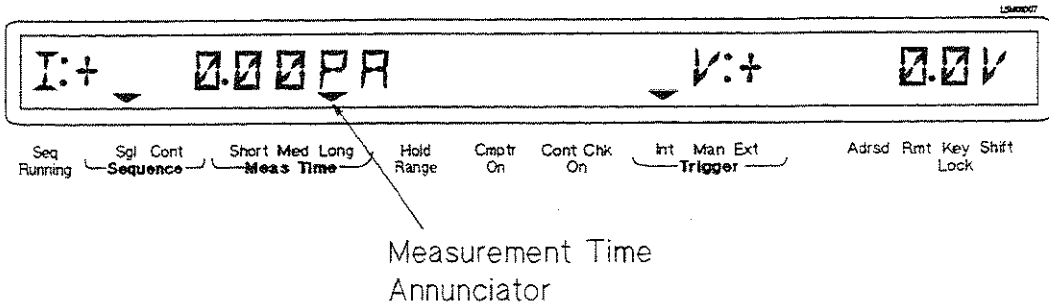
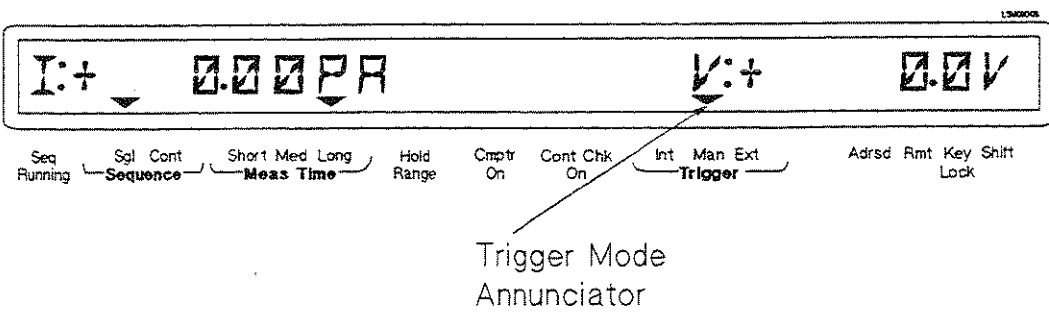

Figure 9-5. RC Box Connection

13. Press to set the measurement parameter to current (I).
14. Press to set the measurement time to LONG. The measurement time is displayed as follows:



15. Press to set the trigger mode to Manual. The trigger mode is displayed as follows:



16. Set the RC Box resistor to $10^{10} \Omega$.

9 Maintenance







17. Set the source voltage to 1 V using the following procedure:
 - a. Press  to display the source voltage setting.
 - b. Press   to set the source voltage to 1 V.
 - c. Confirm that + 1 V is displayed.
18. Press  to turn the source voltage ON. (V Output indicator turns ON.)
19. Press  to measure.
20. Record the multimeter reading on the calculation sheet on the Multimeter Reading line.
21. Record the HP 4339A reading on the calculation sheet on the HP 4339A Reading line.
22. Press  to turn the source voltage OFF. (V Output indicator turns OFF.)
23. Calculate the test result according to the calculation sheet, and record the result into the performance test record.
24. Perform this test for all settings listed in Table 9-3. The source voltage must be turned OFF after each test.

Table 9-3. Current Measurement Accuracy Test Settings

Test Current	Resistor Setting	Voltage Setting	Measurement Time
100 pA	$10^{10} \Omega$	1 V	LONG
1 nA	$10^9 \Omega$	1 V	LONG
10 nA	$10^8 \Omega$	1 V	LONG
100 nA	$10^7 \Omega$	1 V	LONG
1 μ A	$10^6 \Omega$	1 V	LONG
10 μ A	$10^5 \Omega$	1 V	LONG
100 μ A	$10^5 \Omega$	10 V	SHORT

Resistance Measurement Accuracy Test

The HP 4339A measures the resistance values of the calibrated RC Box, and these measurements are compared with the RC Box's calibration values.

Specification

Basic Measurement Accuracy: $\pm 0.6\%$ (See Chapter 8 General Information for details.)

Test Equipment











Description	Recommended Model
RC Box	HP 16340A
RC Box Adapter	PN 04339-65005

Procedure

Warning When the High Voltage indicator is lit, the HP 4339A outputs high voltages of up to 1000 Vdc maximum.



Resistance Measurement Accuracy Test (Floating Device).

1. Record the HP 16340A RC Box calibration values into the Calculation Sheet.
2. Reset the HP 4339A using the following procedure:
 - a. Press   to display the system reset setting.
 - b. Press  until *YES* blinks, then press .
3. Set the Offset-error Canceling to ON using the following procedure:
 - a. Press   to display the configuration setting menu.
 - b. Press  until *OFST* blinks, then press .
 - c. Press  until *ON* blinks, then press  two times.
4. Set up the equipment as shown in Figure 9-6.

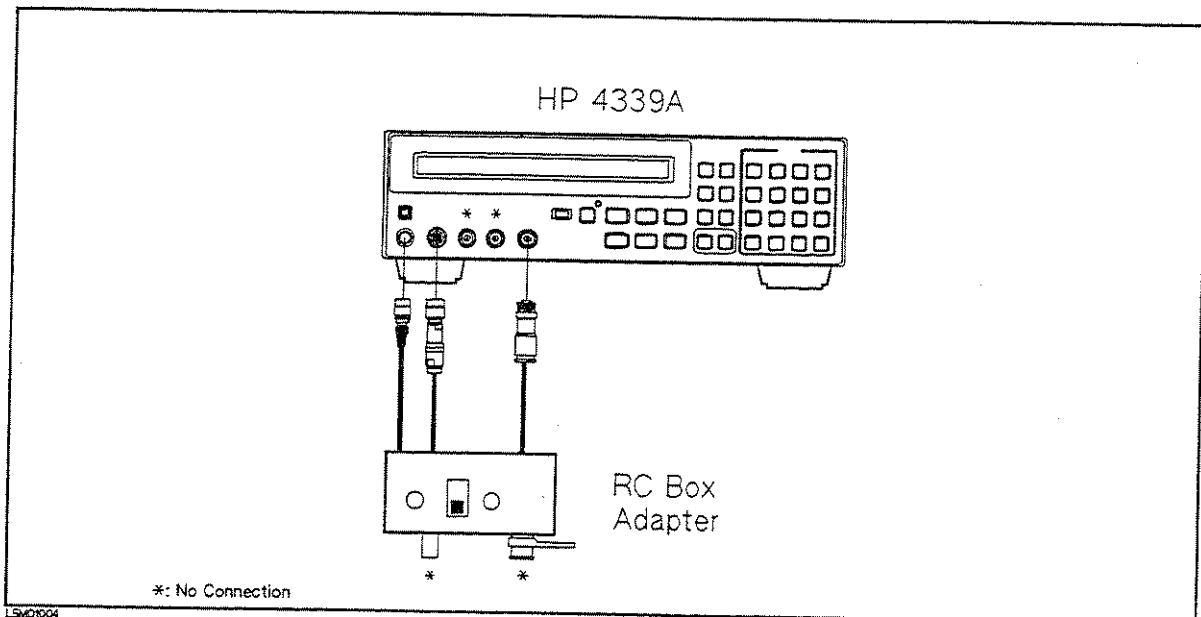













Figure 9-6. Resistance Measurement Accuracy Test Setup (Floating)

5. Set the RC Box Adapter switch to the *F* position.
6. Press   to perform the calibration.
7. Set the source voltage to 100 V using the following procedure:
 - a. Press  to display the source voltage setting.
 - b. Press     to set the source voltage to 100 V.
 - c. Confirm that + 100 V is displayed.
8. Press  to turn the source voltage ON. (V Output indicator turns ON.)
9. Press   to perform the open correction.
10. Press  to turn the source voltage OFF. (V Output indicator turns OFF.)
11. Connect the RC Box to the RC Box Adapter as shown in Figure 9-7

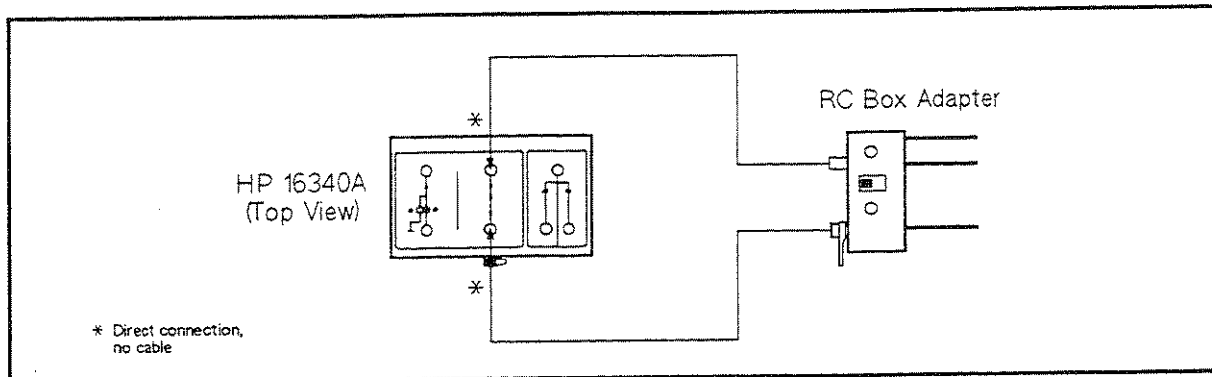
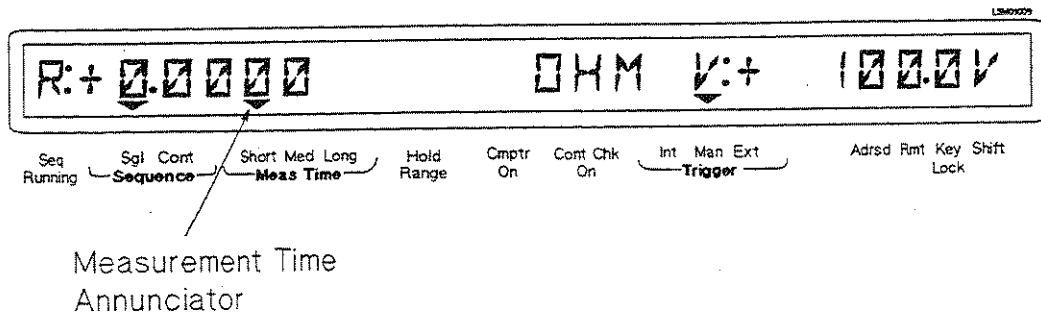
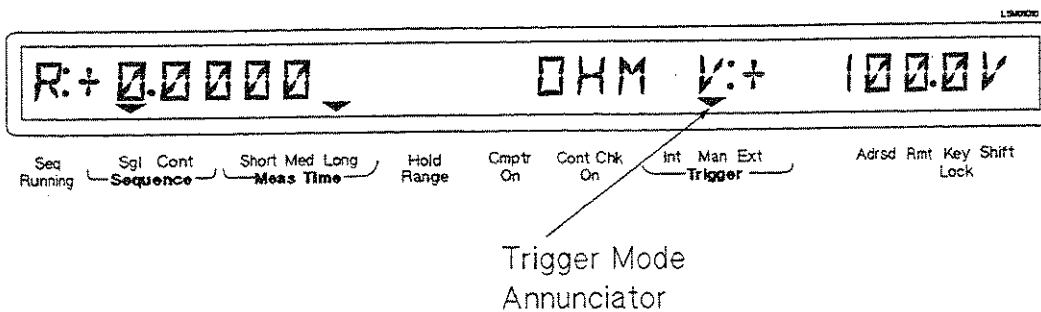

Figure 9-7. RC Box Connection (Floating)

- Press to set the measurement time to SHORT. The measurement time is displayed as follows:



- Press to set the trigger mode to Manual. The trigger mode is displayed as follows:



- Set the RC Box resistor to $10^6 \Omega$.
- Press to turn the source voltage ON. (V Output indicator lights.)
- Press to measure.
- Record the HP 4339A reading on the calculation sheet.

9 Maintenance

18. Press  to turn the source voltage OFF. (V Output indicator turns OFF.)
19. Calculate the test result according to the calculation sheet, and record the result into the performance test record.
20. Perform the test for all settings listed in Table 9-4. The source voltage must be turned OFF after each test. In the test for the $10^{11} \Omega$ resistor, connect the RC Box Adapter to the 10^{11} terminals and set the 10^{11} switch to the BNC connector position as shown in Figure 9-8.

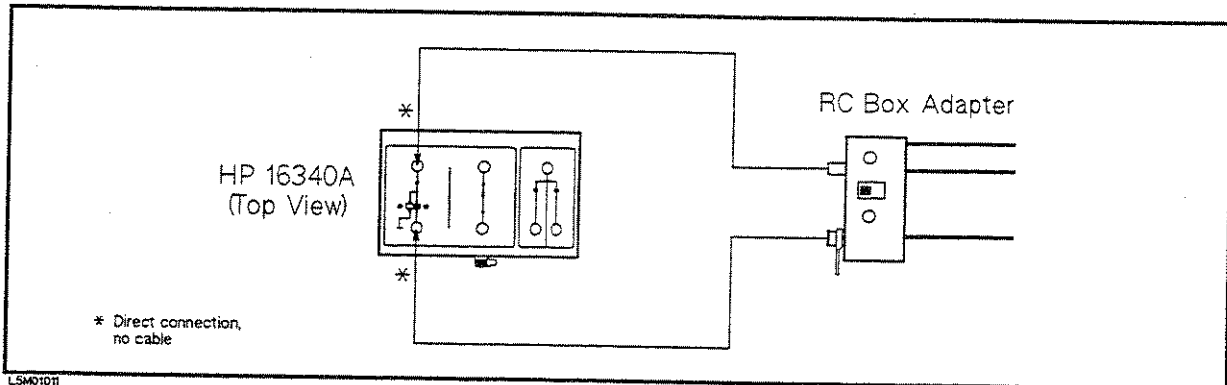

Figure 9-8. RC Box Connection for $10^{11} \Omega$ Resistor

Table 9-4. Resistance Measurement Accuracy Test Settings

Resistor Setting	Voltage Setting	Measurement Time
$10^6 \Omega$	100 V	Short
$10^7 \Omega$	100 V	Long
$10^8 \Omega$	100 V	Long
$10^9 \Omega$	100 V	Long
$10^{10} \Omega$	100 V	Long
$10^{11} \Omega$	100 V	Long
$10^{11} \Omega$	100 V	Short
$10^{11} \Omega$	10 V	Long

Resistance Measurement Accuracy Test (Grounded Device).

21. Set up the equipment as shown in Figure 9-9.

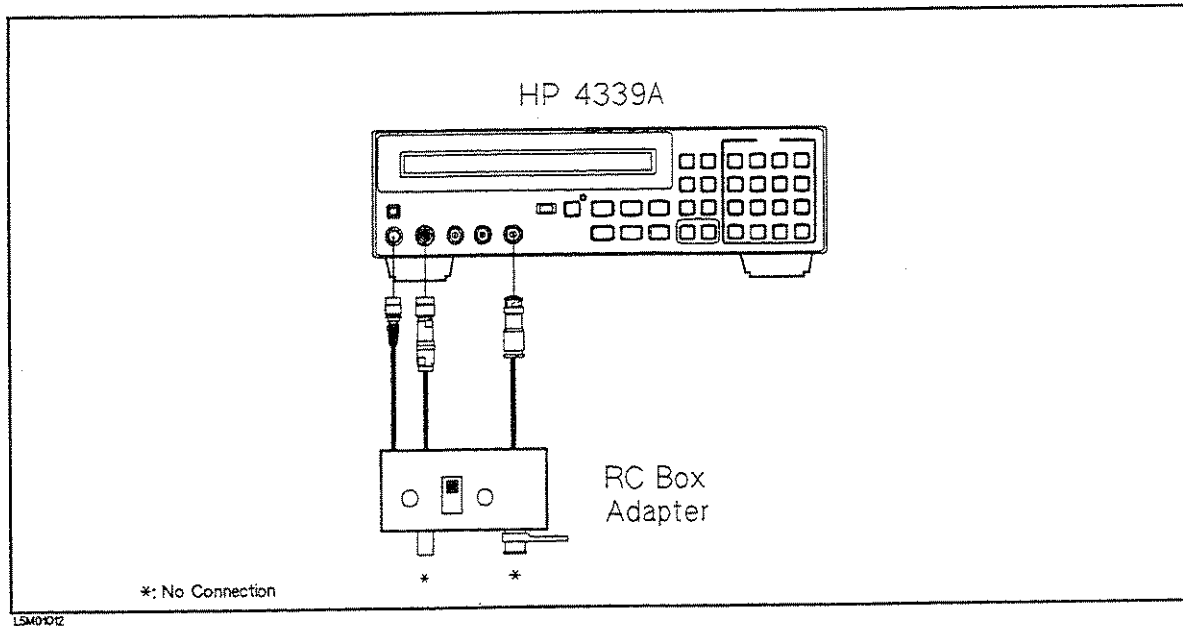











Figure 9-9. Resistance Measurement Accuracy Test Setup (Grounded)

9 Maintenance

22. Set the RC Box Adapter switch to the G position.
23. Set the source voltage to 100 V using the following procedure:
 - a. Press  to display the source voltage setting.
 - b. Press     to set the source voltage to 100 V.
 - c. Confirm that + 100 V is displayed.
24. Press  to turn the source voltage ON. (V Output indicator turns ON.)
25. Press   to perform the open correction.
26. Press  to turn the source voltage OFF. (V Output indicator turns OFF.)
27. Connect the RC Box to the RC Box Adapter as shown in Figure 9-10.

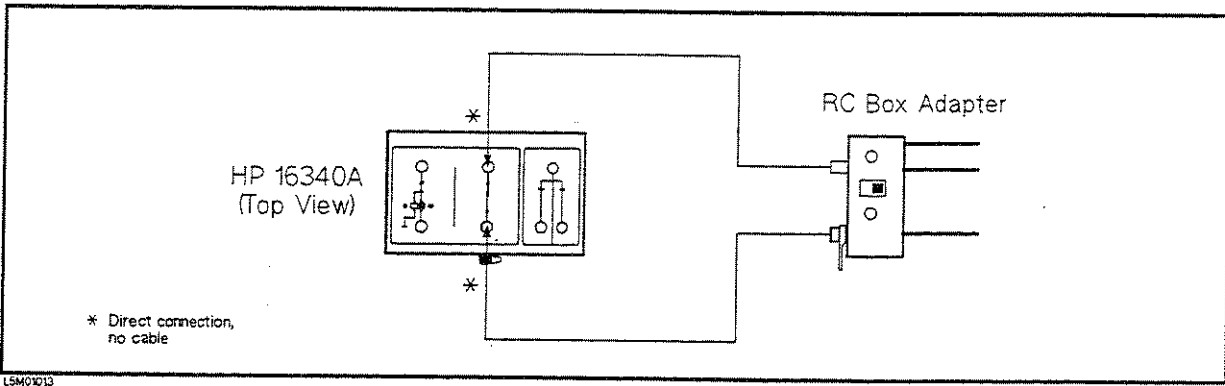

Figure 9-10. RC Box Connection (Grounded)



28. Set the RC Box resistor to $10^7 \Omega$.
29. Press  to turn the source voltage ON. (V Output indicator turns ON.)
30. Press  to measure.
31. Record the HP 4339A reading on the calculation sheet.
32. Press  to turn the source voltage OFF. (V Output indicator turns OFF.)
33. Calculate the test result according to the calculation sheet, and record the result into the performance test record.
34. Perform this test for all settings listed in Table 9-5. The source voltage must be turned OFF after each test.

Table 9-5.
Resistance Measurement Accuracy Test Settings (Grounded)

Resistor Setting	Voltage Setting
$10^7 \Omega$	100 V
$10^{11} \Omega$	10 V

Calculation Sheet

Source Voltage Accuracy Test

Source Voltage Setting	Multimeter Reading [a]	Test Result Equation
0 V	_____ V	a
10 V	_____ V	a - 10.000 V
25 V	_____ V	a - 25.000 V
50 V	_____ V	a - 50.000 V
100 V	_____ V	a - 100.00 V
200 V	_____ V	a - 200.00 V
201 V	_____ V	a - 201.00 V
250 V	_____ V	a - 250.00 V
500 V	_____ V	a - 500.00 V
1000 V	_____ V	a - 1000.0 V

Ammeter Input Resistance Test

10 ⁴ Ω Calibration Value [a]	Offset Voltage [b]	L Voltage [c]	H Voltage [d]	Test Result Equation
_____ × 10 ⁴ Ω	_____ mV	_____ mV	_____ mV	1 kΩ - a × (c - b) ÷ (d - c)

RC Box Calibration Values

This table is used in the Current Measurement Accuracy Test and the Resistance Measurement Accuracy Test.

Resistor Setting	Resistor Calibration Value	Reference Designation
10 ¹¹ Ω	_____ × 10 ¹¹ Ω	cv1
10 ¹⁰ Ω	_____ × 10 ¹⁰ Ω	cv2
10 ⁹ Ω	_____ × 10 ⁹ Ω	cv3
10 ⁸ Ω	_____ × 10 ⁸ Ω	cv4
10 ⁷ Ω	_____ × 10 ⁷ Ω	cv5
10 ⁶ Ω	_____ × 10 ⁶ Ω	cv6
10 ⁵ Ω	_____ × 10 ⁵ Ω	cv7

9 Maintenance

Current Measurement Accuracy Test

Test Current	Resistor Setting	Voltage Setting	Multimeter Reading [a]	HP 4339A Reading [b]	Test Result Equation ¹
100 pA	10 ¹⁰ Ω	1 V	_____ V	_____ pA	b - a ÷ cv2
1 nA	10 ⁹ Ω	1 V	_____ V	_____ nA	b - a ÷ cv3
10 nA	10 ⁸ Ω	1 V	_____ V	_____ nA	b - a ÷ cv4
100 nA	10 ⁷ Ω	1 V	_____ V	_____ nA	b - a ÷ cv5
1 μA	10 ⁶ Ω	1 V	_____ V	_____ μA	b - a ÷ (cv6 + 1 kΩ)
10 μA	10 ⁵ Ω	1 V	_____ V	_____ μA	b - a ÷ (cv7 + 1 kΩ)
100 μA	10 ⁵ Ω	10 V	_____ V	_____ μA	b - a ÷ (cv7 + 1 kΩ)

¹ 1 kΩ in the test result equation is the input resistance of the HP 4339A's ammeter.

Resistance Measurement Accuracy Test

Resistance Measurement Accuracy Test (Floating Device)

Resistor Setting	Voltage Setting	Measurement Time	HP 4339A Reading [a]	Test Result Equation
10 ⁶ Ω	100 V	Short	_____ × 10 ⁶ Ω	a - cv6
10 ⁷ Ω	100 V	Long	_____ × 10 ⁷ Ω	a - cv5
10 ⁸ Ω	100 V	Long	_____ × 10 ⁸ Ω	a - cv4
10 ⁹ Ω	100 V	Long	_____ × 10 ⁹ Ω	a - cv3
10 ¹⁰ Ω	100 V	Long	_____ × 10 ¹⁰ Ω	a - cv2
10 ¹¹ Ω	100 V	Long	_____ × 10 ¹¹ Ω	a - cv1
10 ¹¹ Ω	100 V	Short	_____ × 10 ¹¹ Ω	a - cv1
10 ¹¹ Ω	10 V	Long	_____ × 10 ¹¹ Ω	a - cv1

Resistance Measurement Accuracy Test (Grounded Device)

Resistor Setting	Voltage Setting	HP 4339A Reading [a]	Test Result Equation
10 ⁷ Ω	100 V	_____ × 10 ⁷ Ω	a - cv5
10 ¹¹ Ω	10 V	_____ × 10 ¹¹ Ω	a - cv1

Performance Test Record

Hewlett-Packard 4339A High Resistance Meter

Serial No.: _____

Date: _____

Temperature: _____

Tested by: _____

Humidity: _____

Source Voltage Accuracy Test

Source Voltage Setting	Test Limits	Test Result ¹	Measurement Uncertainty
0 V	±0.10 V	_____ V	± 0.000002 V
10 V	±0.12 V	_____ V	± 0.00018 V
25 V	±0.14 V	_____ V	± 0.00073 V
50 V	±0.18 V	_____ V	± 0.00073 V
100 V	±0.26 V	_____ V	± 0.0022 V
200 V	±0.42 V	_____ V	± 0.0043 V
201 V	±0.82 V	_____ V	± 0.0043 V
250 V	±0.90 V	_____ V	± 0.0028 V
500 V	±1.3 V	_____ V	± 0.0086 V
1000 V	±2.1 V	_____ V	± 0.011 V

¹ Test Result = Measured Value - Setting Value

Ammeter Offset Voltage and Input Resistance Test

Ammeter Offset Voltage Test

Test Limits	Test Result	Measurement Uncertainty
±0.5 mV	_____ mV	±0.0015 mV

Ammeter Input Resistance Test

Test Limits	Test Result ¹	Measurement Uncertainty
± 50 Ω	_____ Ω	±0.52 Ω

¹ Test Result = Typical Value of 1 kΩ - Measured Value



Current Measurement Accuracy Test

Test Current	Test Limits	Measurement Time	Test Result ¹	Measurement Uncertainty
100 pA	±2.6 pA	Long	_____ pA	±0.56 pA
1 nA	±0.0094 nA	Long	_____ nA	±0.0016 nA
10 nA	±0.063 nA	Long	_____ nA	±0.011 nA
100 nA	±0.53 nA	Long	_____ nA	±0.10 nA
1 μA	±0.0043 μA	Long	_____ μA	±0.0005 μA
10 μA	±0.036 μA	Long	_____ μA	±0.007 μA
100 μA	±0.60 μA	Short	_____ μA	±0.07 μA

¹ Test Result = HP 4339A Reading - (Multimeter Reading ÷ Resistor Calibration Value)

Resistance Measurement Accuracy Test

Resistance Measurement Accuracy Test (Floating Device)

Resistor Setting	Voltage Setting	Measurement Time	Test Limits	Test Result ¹	Measurement Uncertainty
10 ⁶ Ω	100 V	Short	±0.0086 × 10 ⁶ Ω	_____ × 10 ⁶ Ω	±0.0010 × 10 ⁶ Ω
10 ⁷ Ω	100 V	Long	±0.0063 × 10 ⁷ Ω	_____ × 10 ⁷ Ω	±0.0010 × 10 ⁷ Ω
10 ⁸ Ω	100 V	Long	±0.0073 × 10 ⁸ Ω	_____ × 10 ⁸ Ω	±0.0011 × 10 ⁸ Ω
10 ⁹ Ω	100 V	Long	±0.0093 × 10 ⁹ Ω	_____ × 10 ⁹ Ω	±0.0016 × 10 ⁹ Ω
10 ¹⁰ Ω	100 V	Long	±0.0273 × 10 ¹⁰ Ω	_____ × 10 ¹⁰ Ω	±0.0056 × 10 ¹⁰ Ω
10 ¹¹ Ω	100 V	Long	±0.0453 × 10 ¹¹ Ω	_____ × 10 ¹¹ Ω	±0.010 × 10 ¹¹ Ω
10 ¹¹ Ω	100 V	Short	±0.0550 × 10 ¹¹ Ω	_____ × 10 ¹¹ Ω	±0.010 × 10 ¹¹ Ω
10 ¹¹ Ω	10 V	Long	±0.0546 × 10 ¹¹ Ω	_____ × 10 ¹¹ Ω	±0.010 × 10 ¹¹ Ω

¹ Test Result = HP 4339A Reading - Resistor Calibration Value

Resistance Measurement Accuracy Test (Grounded Device)

Resistor Setting	Voltage Setting	Test Limits	Test Result ¹	Measurement Uncertainty
10 ⁷ Ω	100 V	±0.0065 × 10 ⁷ Ω	_____ × 10 ⁷ Ω	±0.0010 × 10 ⁷ Ω
10 ¹¹ Ω	10 V	±0.0573 × 10 ¹¹ Ω	_____ × 10 ¹¹ Ω	±0.010 × 10 ¹¹ Ω

¹ Test Result = HP 4339A Reading - Resistor Calibration Value

Functional Test

Introduction

This section provides the test procedures used to verify that the HP 4339A performs its designed functions. The functional tests can be used for post-repair function verification.

Test Equipment

Table 9-1 lists the test equipment required to perform the tests described in this section. Equipment which equals or surpasses the key required specifications of the recommended equipment may be used.

Handler Interface Functional Test

The HP 4339A's handler interface function is tested using the built-in selftest and the handler interface tester.

Test Equipment

Description	Recommended Model
Handler Interface Tester	04339-65007

Procedure

Initial Setup.

1. Turn the HP 4339A OFF.
2. Set the LED_PW switch on the Handler Interface Tester to *OFF*, and set the IN1, IN2, IN3, and IN4 switches to *0*.
3. Set up the equipment as shown in Figure 9-11

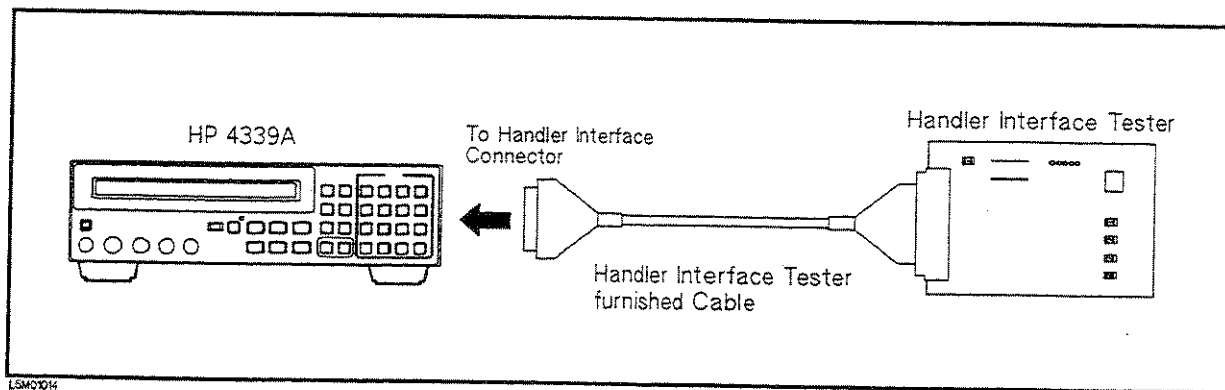







Figure 9-11. Handler Interface Functional Test Setup

4. Turn the HP 4339A ON.
5. Reset the HP 4339A using the following procedure.
 - a. Press   to display the system reset settings.
 - b. Press  until *YES* blinks, then press .

Key Lock Function Test.

6. Set the *IN4* switch on the Handler Interface Tester to *1*.
7. Confirm that the all keys on the HP 4339A's front panel are locked out.
8. Set the *IN4* switch on the Handler Interface Tester to *0*.







External Trigger Function Test.

9. Press  to set the trigger mode to External.
10. Press  to set the measurement mode to current (I).

11. Press the *IN5* switch on the Handler Interface Tester, and confirm that the HP 4339A is triggered.

Handler Interface Output Test.

12. Start the handler interface output test using the following procedure:

- a. Press   to display the configuration setting menu.
- b. Press  until *SVC* blinks, then press .
- c. Press  until *HNDL* blinks, then press .

13. Set the *LED_PW* switch on the Handler Interface Tester to *ON*.

Warning Don't set the *LED_PW* switch to *ON*, except when doing the handler interface output test. The LEDs may cause the HP 4339A to shut-down during normal operation.



14. Confirm that the LEDs on the Handler Interface Tester light in the order shown in Figure 9-12, in accordance with the HP 4339A display.

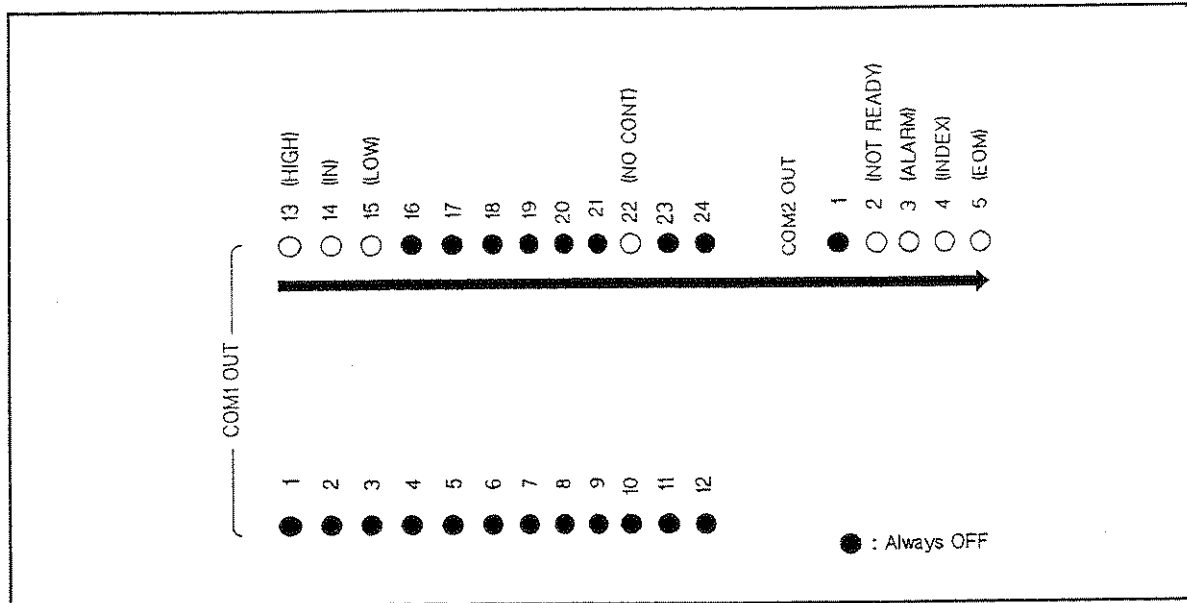



Figure 9-12. Handler Interface Output Order

15. Set the *LED_PW* switch on the Handler Interface Tester to OFF.
16. Press  twice to exit from the test mode.





Contact Check Functional Test

The HP 4339A's contact check function is confirmed.

Test Equipment

	Description	Recommended Model
RC Box		HP 16340A
RC Box Adapter		04339-65005

Procedure

1. Reset the HP 4339A using the following procedure:
 - a. Press   to display the system reset settings.
 - b. Press  until *YES* blinks, then press .
2. Set up the equipment as shown in Figure 9-13.

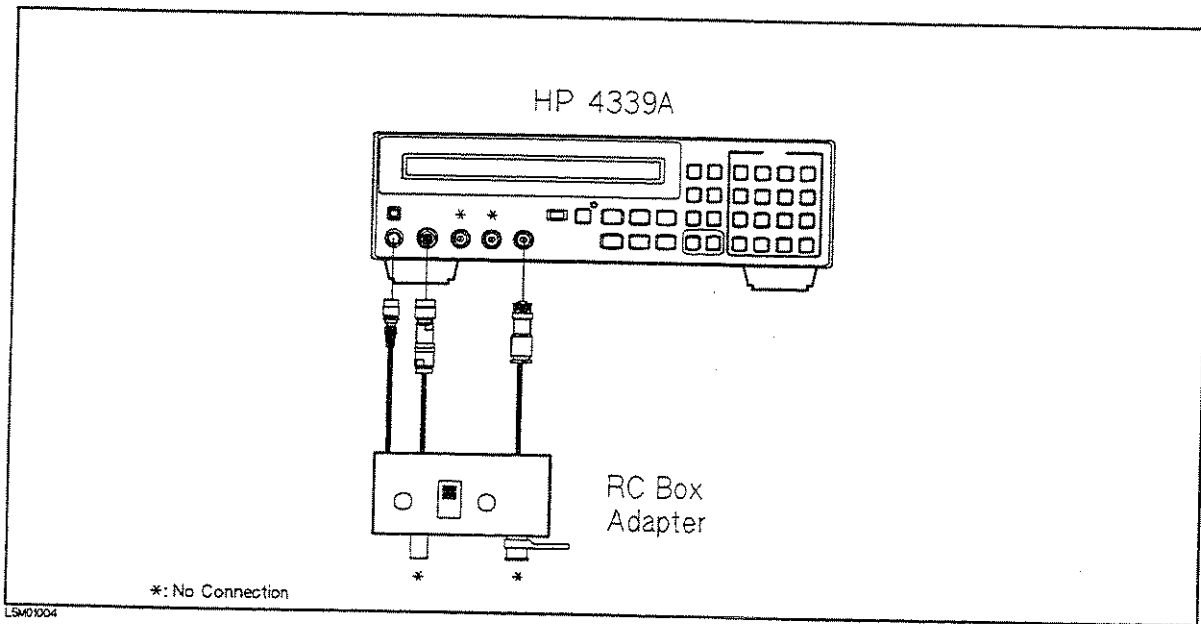









Figure 9-13. Contact Check Functional Test Setup

3. Set the RC Box Adapter switch to the *G* position.
4. Set the measurement range to 10 μ A using the following procedure:
 - a. Press   to display the measurement range setting.
 - b. Press  until 10 μ A appears, then press .
5. Press   to perform the OPEN correction.

6. Press   to turn the contact check function on.
7. Confirm that the HP 4339A displays *N.C.* (No Contact).
8. Set the HP 16340A RC Box resistor to $10^4 \Omega$.
9. Connect the RC Box to the RC Box Adapter as shown in Figure 9-14.

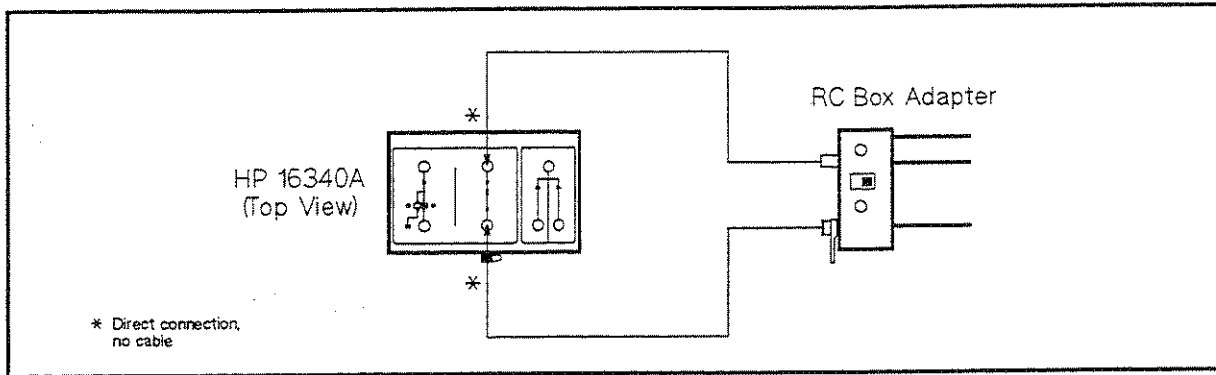

Figure 9-14. Contact Check Functional Test Setup

10. Confirm that the *N.C.* disappears and the HP 4339A displays the resistance measurement value.

Handwritten text, possibly bleed-through from the reverse side of the page, running vertically along the right edge.

Manual Changes

This appendix contains the information required to adapt this manual to earlier versions or configurations of the HP 4339A than that of the current printing date of this manual. The information in this manual applies directly to an HP 4339A whose serial number prefix is listed on the title page of this manual.

Serial Number

Hewlett-Packard uses a two-section, nine-character serial number which is stamped on the serial number plate attached to the instrument's rear panel. The first four digits and a letter are the serial number prefix, and the last five digits are the suffix. The letter placed between the two sections identifies the country where the instrument was manufactured. The prefix is the same for all identical instruments; it changes only when a change is made to the instrument. The contents of this manual apply to instruments with the serial number prefix(es) listed under the serial numbers on the title page of this manual.

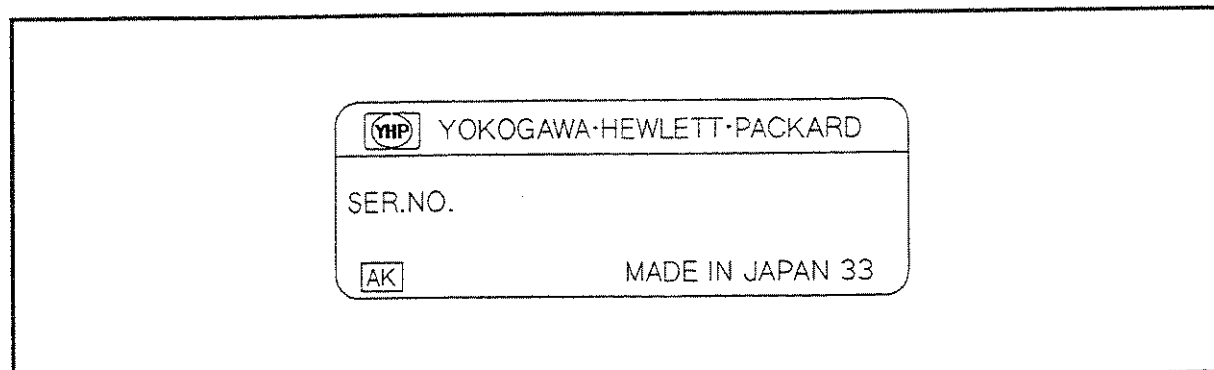

L5007001

Figure A-1. Serial Number Plate

An instrument manufactured after the printing date of this manual may have a serial number prefix that is not listed on the title page. This unlisted serial number prefix indicates the instrument is different from those described in this manual. The manual for this new instrument may be accompanied by a yellow Manual Change supplement or have a different manual part number. This sheet contains "manual change information" that explains how to adapt the manual to the newer instrument.

In addition to change information, the supplement may contain information for correcting errors (Errata) in the manual. To keep this manual as current and accurate as possible, Hewlett-Packard recommends that you periodically request the latest Manual Changes supplement. The supplement for this manual is identified by this manual's printing date and its part number, both of which appear on the manual's title page. Complimentary copies of the supplement are available from Hewlett-Packard. For information concerning a serial number

prefix that is not listed on the title page or in the Manual Change supplement, contact your nearest Hewlett-Packard office.

Manual Changes

To adapt this manual to your HP 4339A, refer to Table A-1, and make all of the manual changes listed opposite your instrument's serial number.

Instruments manufactured after the printing of this manual may be different than those documented in this manual. Later instrument versions will be documented in a manual change supplement that will accompany the manual shipped with that instrument. If your instrument serial number is not listed on the title page of this manual or in Table A-1, it may be documented in a yellow *MANUAL CHANGES* supplement.

Table A-1. Manual Changes by Serial Number

Serial Prefix or Number	Manual Changes
	There are no earlier configurations than the printing date of this manual.

Handler Interface Installation

This section describes how to connect pull-up resistors to enable the output signals, and how to set the dip switch to select voltage levels for the input signals. These procedures must be done before using the handler interface. Refer to "Handler Interface" in Chapter 3 for more information.

Caution SUSCEPTIBLE TO DAMAGE FROM ESD.



Perform the following procedures only at a static-safe workstation and wear a grounding strap.

Caution Be careful not to short the circuit when performing the following procedures. For example:



- Solder cleanly and carefully.
 - Guard against hair or dust getting on the circuit.
 - Do *not* damage the boards, wires, or parts on the board.
-

Tools and Fasteners

The HP 4339A mechanical components are secured using metric threaded fasteners. Many fasteners in the HP 4339A may appear to be Phillips type, but they are Pozidrive type fasteners. To avoid damaging them, use only Pozidrive screwdrivers to remove or tighten pozidrive type fasteners.

Procedure

1. Disconnect the power cable from the HP 4339A and allow enough time (a few minutes) for the internal capacitors to discharge.

Warning Dangerous energy and voltage levels exist within the HP 4339A when it is in operation and just after it is powered down. Allow a few minutes for the HP 4339A's internal capacitors to discharge before starting to work on it.

2. Remove the two screws which fasten the cover to the chassis rear panel.
3. Slide the cover toward the rear while holding the front panel bezel.

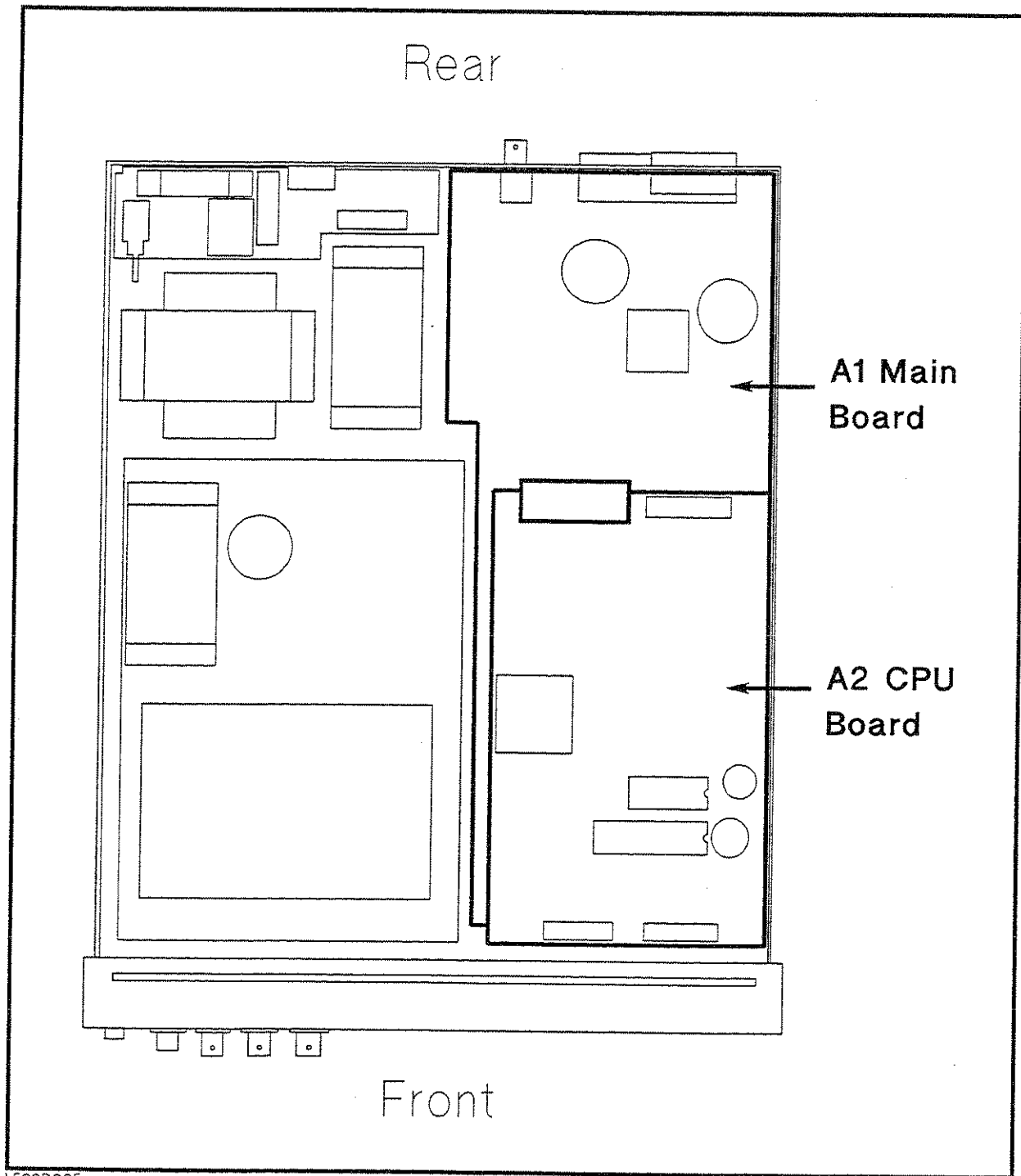

L500B005

Figure B-1. Top View of HP 4339A with Cover Removed

4. Remove the A2 CPU board assembly.
 - a. Disconnect the four flatcable assemblies from the A2 board.
 - b. Remove the four screws that secure the A1 board to the stud.
 - c. Remove the A2 board from the chassis.

5. Remove the A1 board assembly.
 - a. Disconnect the following cable assemblies from the A1 board.
 - i. Four cable assemblies form the front panel
 - ii. The cable assembly from the transformer
 - iii. Two cable assemblies form the DC-DC Converter
 - b. Disconnect the four optical fiber cables which are connected to the A# Ammeter Board Assembly
 - c. Disconnect the four optical fiber cables form the A3 Ammeter Board Assembly

Caution

To avoid damaging the optical fiber cable by bending or other mechanical stress, remove all the fiber cables form the HP 4339A when replacing either the A1 board or the A3 board.

- d. Remove the cable clamp on the shield case that surrounds the A3 board.
- e. Remove the nut that fastens the Ext Trigger connector on the rear panel.
- f. Remove the screw that secures the A1 board to the chassis side.
- g. Remove the four studs, that secure the A1 assembly to the chassis, by rotating the studs with a flat-bladed screwdriver.
- h. Remove the three screws that secure the A1 assembly to the chassis
- i. Remove the A1 assembly form the chassis

Figure B-2 shows the location of the sockets in which the pull-up resistors (J11) and the switch with which to select the voltage value of EXT DCV2. Table B-1 lists the socket numbers for each control signal and comparison signal.

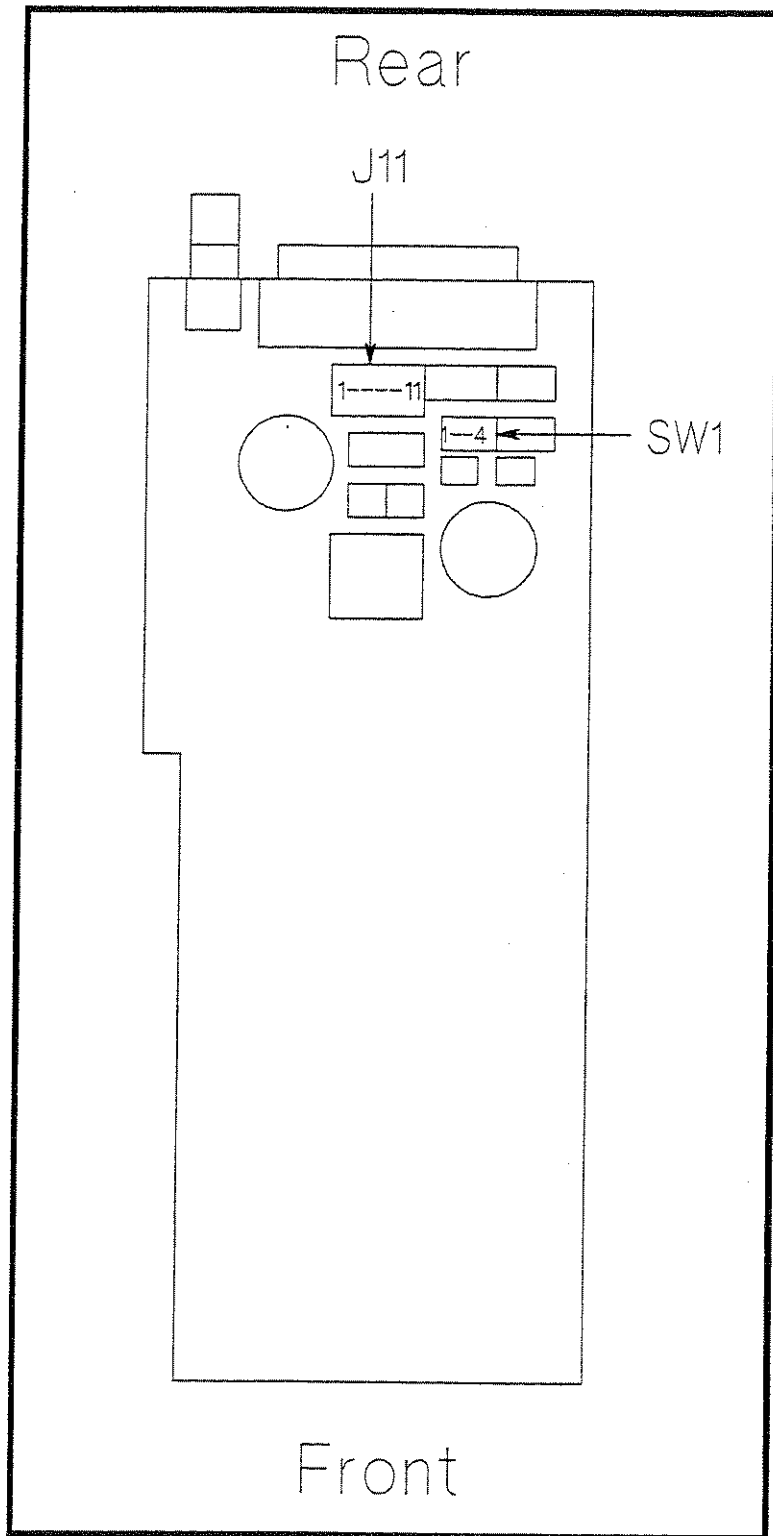

L500B004

Figure B-2. A1 Main Board

Table B-1. Pull-up Resistor Location

Socket No.	Signal Name	Signal Type
J11-1	/INDEX	Control Signal (5 to 15 V)
J11-2	/EOM	
J11-3	/ALARM	
J11-4	/NOT READY	
J11-5	/NO CONTACT	Comparison Signal (5 to 24 V)
J11-6	/LO	
J11-7	/HI	
J11-8	/IN	
J11-9	Not Used	
J11-10		
J11-11		

6. Mount the pull-up resistors for the comparison output signals. (Refer to Figure B-2 and Table B-1 for the location of the pull-up resistors for the comparison output signals.) Use the following equation to determine the value of the pull-up resistors (R).

$$R \text{ [k}\Omega\text{]} \simeq V_p \text{ [V]} / 3$$

where, V_p is the pull-up voltage.

The typical pull-up resistor values are:

Pull-up Voltage	Pull-up Resistor HP Part Number
5 V	0757-0278 (1.78 k Ω)
12 V	0757-0279 (3.16 k Ω)
24 V	0757-0441 (8.25 k Ω)

7. Mount the pull-up resistors for the control output signals. (Refer to Figure B-2 and Table B-1 for the location of the pull-up resistors for the control output signals.) Use the following equation to determine the value of the pull-up resistors (R).

$$R \text{ [k}\Omega\text{]} \simeq V_p \text{ [V]} / 2.5$$

where, V_p is the pull-up voltage.

The typical pull-up resistor values are:

Pull-up Voltage	Pull-up Resistor HP Part Number
5 V	0757-0278 (1.78 k Ω)
9 V	0757-0279 (3.16 k Ω)
12 V	0698-3154 (4.22 k Ω)
15 V	0757-0438 (5.11 k Ω)

8. Set SW1 according to the voltage value of EXT DCV2.

Procedure

HP 4339A

EXT DCV2	EXT TRIG		KEY LOCK	HV OFF
	SW1-1	SW1-2	SW1-3	SW1-4
5 to 6 V	Close	Close	Close	Close
6 to 9 V	Close	Open	Close	Close
9 to 15 V	Open	Close	Open	Close

9. Reinstall the A1 main board, the A2 board, and the cover.

Error Messages

This section lists the messages that are displayed on the HP 4339A's LCD display or transmitted by the instrument over HP-IB, in numerical order.

When an error is displayed on the LCD display,

- For instrument errors, E is added in front of error number as follows:

L50MSG01

E 16 :PREV SETTING LOST

Seq Running Sgl Sequence Cont Short Med Long Meas Time Hold Range Cmptr On Cont Chk On Int Man Ext Trigger Adrsd Rmt Key Shift Lock

- For HP-IB errors, only the error number is displayed as follows:

L50MSG02

HP-IB ERROR: - 101

Seq Running Sgl Sequence Cont Short Med Long Meas Time Hold Range Cmptr On Cont Chk On Int Man Ext Trigger Adrsd Rmt Key Shift Lock

In the explanation of many error commands, section numbers of the IEEE standard 488.2 are included. Refer to them for further information about an error with these IEEE section numbers.

Out of Range

OVER CURRENT

The current limit is working and the source output is reduced. Lower the test voltage value, or raise the current limit value.

OVLD

The measured value is out of the measurable range. Change the measurement range appropriately, or use the Auto range mode.

Warning

WARNING: FIXTURE LEAKAGE

When an OPEN correction is performed, the leakage current is high but it is less than the correction limit. (The measured leakage current is more than about 10 pA and less than about 10 μ A.) So you may not be able to measure lower values accuracy.

Instrument Errors

11 ADC FAILURE

The A/D conversion failed. The HP 4339A stops operation and asserts the /ALARM signal on the handler interface. Contact your nearest Hewlett-Packard office.

12 ROM TEST FAILED

The ROM failed. When this error occurs during power-on test, the HP 4339A stops operation and asserts the /ALARM signal on the handler interface. When this error occurs during self-test, the HP 4339A continues operation and asserts the /ALARM signal. Contact your nearest Hewlett-Packard office.

13 RAM TEST FAILED

The RAM failed. The HP 4339A stops operation and asserts the /ALARM signal on the handler interface. Contact your nearest Hewlett-Packard office.

14 EEPROM R/W FAILED

The EEPROM read/write test failed. The HP 4339A stops operation and asserts the /ALARM signal on the handler interface. Contact your nearest Hewlett-Packard office.

15 USER DATA LOST

Correction data and instrument settings saved in EEPROM have been lost. When this error occurs during power-on test, the HP 4339A sets the data in the EEPROM to the factory default settings, continues operation, and does not assert the /ALARM signal on the handler interface. When this error occurs during self-test, the HP 4339A continues the operation and asserts the /ALARM signal. Contact your nearest Hewlett-Packard office.

16 PREV. SETTING LOST

Instrument settings in the backup memory have been lost. The instrument keeps instrument settings in backup memory for 72 hours after being turned OFF. When this error occurs during power-on test, the HP 4339A continues operation and does not assert the /ALARM signal on the handler interface. When this error occurs during self-test, the HP 4339A stops operation and asserts the /ALARM signal.

17 SAVE FAILED

The instrument setting was not be saved. (If the error is detected in the EEPROM, error 14 is displayed.) The HP 4339A continues operation and does not assert the /ALARM signal on the handler interface.

18 RECALL FAILED

No instrument setting saved in the EEPROM. (If the error is detected in the EEPROM, error 14 is displayed.) The HP 4339A continues operation and does not assert the /ALARM signal on the handler interface.

19 PRINTER NO RESPONSE

Check the following items:

- Check that the printer is turned on.
- Check that the HP-IB cable is connected between the printer and the instrument.
- Check that the printer is set to "Listen Always."

The HP 4339A continues operation and does not assert the /ALARM signal on the handler interface.

20 A1 BD TEST FAILED

The A1 board failed. When this error occurs during power-on test, the HP 4339A stops operation and asserts the /ALARM signal on the handler interface. When this error occurs during self-test, the HP 4339A continues operation and asserts the /ALARM signal. Contact your nearest Hewlett-Packard office.

21 LOCKOUT BY HANDLER

Front panel key input is disabled by the handler. The front panel key input cannot be enabled by the front panel keys or by HP-IB commands when disabled by the handler. The HP 4339A continues operation and does not assert the /ALARM signal on the handler interface.

31 A3 BD TEST FAILED

The A3 board failed. Contact your nearest Hewlett-Packard office.

32 HIGH LEAKAGE

When an OPEN correction is performed, the leakage current is too high. Check that nothing is connected to the test lead.

33 HIGH STRAY C

When an OPEN correction is performed, the stray capacitance is too high; for example, when you connect a coaxial test lead to a triaxial test lead, the coaxial cable is too long.

34 HIGH OFFSET LEAKAGE

When the calibration or the offset-error canceling is performed, the offset-error is too high. Contact your nearest Hewlett-Packard office.

35 FIXTURE UNKNOWN

An unknown test fixture or test leads is connected to the Interlock connector; for example, when you connect the HP 16117C Test Leads to the HP 4339A, the wiring of the interlock cable is mistaken.

36 INTERLOCK OPEN

Nothing is connected to the Interlock connector or the test fixture's cover is opened.

HP-IB Errors**-100 Command error**

This is a generic syntax error that the HP 4339A cannot detect more specific errors. This code indicates only that a command error, as defined in IEEE 488.2, 11.5.1.1.4, has occurred.

-101 Invalid character

A syntax element contains a character which is invalid for that type; for example, a header containing an ampersand, SENSE&.

-102 Syntax error

An unrecognized command or data type was encountered; for example, a string was received when the HP 4339A was not expecting to receive a string.

-103 Invalid separator

The syntax analyzer was expecting a separator and encountered an illegal character; for example, the semicolon was omitted after a program message unit, *RST:TRIG.

-104 Data type error

The syntax analyzer recognized an unallowed data element; for example, numeric or string data was expected but block data was encountered.

-105 GET not allowed

A Group Execute Trigger (GET) was received within a program message (see IEEE 488.2, 7.7).

-108 Parameter not allowed

More parameters were received than expected for the header; for example, the [SENSE]:AVERAGE:COUNT command only accepts one parameter, so receiving :AVER:COUNT,4 is not allowed.

-109 Missing parameter

Fewer parameters were received than required for the header; for example, the [:SENSe]:AVERag:COUNt command requires one parameter, so receiving only :AVER:COUN is not allowed.

-112 Program mnemonic too long

The header contains more than twelve characters (see IEEE 488.2, 7.6.1.4.1).

-113 Undefined header

The header is syntactically correct, but it is undefined for the HP 4339A; for example, *XYZ is not defined for the HP 4339A.

-121 Invalid character in number

An invalid character for the data type being analyzed syntax parsed was encountered; for example, an alpha character in a decimal numeric or a "9" in octal data.

-123 Exponent too large

The magnitude of the exponent was larger than 32000 (see IEEE 488.2, 7.7.2.4.1).

-124 Too many digits

The mantissa of a decimal numeric data element contains more than 255 digits excluding leading zeros (see IEEE 488.2, 7.7.2.4.1).

-128 Numeric data not allowed

Legal numeric data element was received, but the HP 4339A does not accept it in this position for a header.

-131 Invalid suffix

The suffix does not follow the syntax described in IEEE 488.2, 7.7.3.2, or the suffix is inappropriate for the HP 4339A.

-138 Suffix not allowed

A suffix was encountered after a numeric element which does not allow suffixes.

-140 Character data error

This error, as well as errors -141 through -148, are generated when analyzing the syntax of a character data element. This particular error message is used if the HP 4339A cannot detect a more specific error.

-141 Invalid character data

Either the character data element contains an invalid character or the particular element received is not valid for the header.

-144 Character data too long

The character data element contains more than twelve characters (see IEEE 488.2, 7.7.1.4).

-148 Character data not allowed

A legal character data element was encountered that's prohibited by the HP 4339A.

-150 String data error

This error, as well as errors -151 and -158, are generated when analyzing the syntax of a string data element. This particular error message is used if the HP 4339A cannot detect a more specific error.

-151 Invalid string data

A string data element was expected, but was invalid for some reason (see IEEE 488.2, 7.7.5.2); for example, an END message was received before the terminal quote character.

-158 String data not allowed

A string data element was encountered but was not allowed by the HP 4339A at this point in the syntax analysis process.

-160 Block data error

This error, as well as errors -161 and -168, are generated when analyzing the syntax of a block data element. This particular error message is used if the HP 4339A cannot detect a more specific error.

-161 Invalid block data

A block data element was expected, but was invalid for some reason (see IEEE 488.2, 7.7.6.2); for example, an END message was received before the length was satisfied.

-168 Block data not allowed

A legal block data element was encountered but was not allowed by the HP 4339A at this point in the syntax analysis process.

-170 Expression error

This error, as well as errors -171 and -178, are generated when analyzing the syntax of an expression data element. This particular error message is used if the HP 4339A cannot detect a more specific error.

-171 Invalid expression

The expression data element was invalid (see IEEE 488.2, 7.7.7.2); for example, unmatched parentheses or an illegal character.

-178 Expression data not allowed

A legal expression data was encountered but was not allowed by the HP 4339A at this point in the syntax analysis process.

-200 Execution errors

This is the generic syntax error that the HP 4339A cannot detect more specific errors. This code indicates only that an execution error as defined in IEEE 488.2, 11.5.1.1.5 has occurred.

-211 Trigger ignored

A GET, *TRG, or triggering signal was received and recognized by the HP 4339A but was ignored because of HP 4339A timing considerations; for example, the HP 4339A was not ready to respond.

-213 Init ignored

A request for a measurement initiation was ignored as another measurement was already in progress.

-221 Settings conflict

A legal program data element was analyzed syntax but could not be executed due to the current device state (see IEEE 488.2, 6.4.5.3 and 11.5.1.1.5).

-222 Data out of range

A legal program data element was analyzed syntax but could not be executed because the interpreted value was outside the legal range as defined by the HP 4339A (see IEEE 488.2, 11.5.1.1.5).

-223 Too much data

A legal program data element of block, expression, or string type was received that contained more data than the HP 4339A could handle due to memory or related device-specific requirements.

-230 Data corrupt or stale

Possibly invalid data; new reading started but not completed since last access.

-241 Hardware missing

A legal program command or query could not be executed because of missing HP 4339A hardware; for example, an option was not installed.

-310 System error

Some error, termed "system error" by the HP 4339A, has occurred.

-311 Memory error

An error was detected in the HP 4339A's memory.

-313 Calibration memory lost

The nonvolatile calibration data has been lost. When this error occurs during power-on test, the HP 4339A stops operation and asserts the /ALARM signal on the handler interface. When this error occurs during self-test, the HP 4339A continues operation and asserts the /ALARM signal. Contact your nearest Hewlett-Packard office.

-350 Queue overflow

A specific code entered into the queue in lieu of the code that caused the error. This code indicates that there is no room in the queue and an error occurred but was not recorded.

-400 Query errors

This is the generic query error that the HP 4339A cannot detect more specific errors. This code indicates only that a query error as defined in IEEE 488.2, 11.5.1.1.7 and 6.3 has occurred.

-410 Query INTERRUPTED

A condition causing an interrupted query error occurred (see IEEE 488.2, 6.3.2.3); for example, a query followed by DAB or GET before a response was completely sent.

-420 Query UNTERMINATED

A condition causing an unterminated query error occurred (see IEEE 488.2, 6.3.2.2); for example, the HP 4339A was addressed to talk and an incomplete program message was received by the controller.

-430 Query DEADLOCKED

A condition causing a deadlocked query error occurred (see IEEE 488.2, 6.3.1.7); for example, both input buffer and output buffer are full and the HP 4339A cannot continue.

-440 Query UNTERMINATED after indefinite response

A query was received in the same program message after an query requesting an indefinite response was executed (see IEEE 488.2, 6.5.7.5).

Index

A

- :ABORt, 5-7
- ABORt, 4-11
- ABORt command, 5-7
- Adrs key, 3-11
- [:ALL?]
 - CALibratiOn, 5-14
- ammeter offset voltage and input resistance test, 9-6
- annunciator, 3-2
- ARM, 5-40
 - DELay, 5-40
 - SOURce, 5-40
- ARM event detection state, 5-40
- :ARM[:SEQuence1] [:LAYer]:DELay, 4-15
- :ARM[:SEQuence1] [:LAYer]:SOURce, 4-15
- ARM subsystem, 5-8
- Arrow key, 3-13
- ASCII, 5-19, 5-42
- :AUTO
 - CALibratiOn, 5-14
 - SENSe:CURRent:RANGe, 5-23
- Auto/Hold key, 3-10
- Auto range, 3-10
- :AVERage:COUNT
 - SENSe, 5-22
- Average key, 3-5
- :AVERage[:STATe]
 - SENSe, 5-22
- averaging rate, 3-5
 - how to set, 2-2, 4-7
 - HP-IB command, 5-22

B

- backup memory, 3-3
- :BEEPer
 - CALCulate:LIMit, 5-10
- beeper, 3-18
 - how to set, 2-12, 4-8
 - HP-IB command, 5-10
- :BEEPer[:IMMEDIATE]
 - SYSTem, 5-27
- :BEEPer:STATe
 - SYSTem, 5-27
- :BEEPer[:STATe]
 - CALCulate:LIMit, 5-10

- Bk Sp key, 3-13
- BLUE shift key, 3-13
- <Boolean>, 5-4
- bus trigger mode, 3-11, 4-12

C

- :CALCulate:FORMat, 4-5
- :CALCulate:LIMit:BEEPer[:CONDition], 4-8
- :CALCulate:LIMit:BEEPer[:STATe], 4-8
- :CALCulate:LIMit:CLEAR, 4-9
- :CALCulate:LIMit:FAIL?, 4-9
- :CALCulate:LIMit:LOWer[:DATA], 4-9
- :CALCulate:LIMit:LOWer:STATe, 4-9
- :CALCulate:LIMit:STATe, 4-9
- :CALCulate:LIMit:UPPER[:DATA], 4-9
- :CALCulate:LIMit:UPPER:STATe, 4-9
- :CALCulate:MATH:EXPRESSION:CATALog?, 4-9
- :CALCulate:MATH:EXPRESSION:NAME, 4-9
- :CALCulate:MATH:STATe, 4-9
- :CALCulate:RESistivity:EARea, 4-8
- :CALCulate:RESistivity:EPERimeter, 4-8
- :CALCulate:RESistivity:GLENGth, 4-8
- :CALCulate:RESistivity:STHickness, 4-8
- CALCulate subsystem, 5-9
- calculation sheet, 9-19
- calibration, 3-14
 - how to perform, 1-17
 - HP-IB command, 5-14
- :CALibratiOn[:ALL]?, 4-6
- :CALibratiOn:AUTO, 4-9
- CALibratiOn subsystem, 5-14
- Cal key, 3-14
- charge time
 - how to set, 2-10
- :CLEAR
 - CALCulate:LIMit, 5-10
- *CLS, 4-17, 5-31
- Command Error (CME) Bit, 5-36
- common command, 5-31
- comparator
 - how to use, 2-6, 4-9
 - HP-IB command, 5-10
 - limit, 3-12
 - on/off, 3-12

- Config key , 3-17
- contact check, 3-14
 - how to perform, 4-8
 - how to set, 2-12
- contact check functional test , 9-26
- :CONtact:VERify
 - SENSe:RESistance, 5-23
- Cont Chk key , 3-14
- :CONtrol
 - DATA:FEED, 5-16
- :CORRection:COLLect[:ACQuire]
 - SENSe, 5-22
- :CORRection[:STATe]
 - SENSe, 5-22
- :COUnT
 - SENSe:AVERage, 5-22
 - TRIGger[:SEQuence1], 5-29
- Cur Limit key , 3-5
- :CURRent:APERture
 - SENSe, 5-23
- current limit, 3-5
 - how to set, 2-12
- :CURRent:LIMit[:AMPLitude]
 - SOURce, 5-24
- current measurement accuracy test , 9-9
- :CURRent:RANGe:AUTO
 - SENSe, 5-23
- :CURRent:RANGe[:UPPer]
 - SENSe, 5-23

D

- :DATA
 - DATA, 5-15
- :DATA?
 - DATA, 5-15
- data buffer, 4-14
- :DATA[:DATA], 4-9
- :DATA[:DATA]?, 4-14
- :DATA:FEED, 4-14
- :DATA:FEED:CONtrol, 4-14
- <data_handle>, 5-4
- :DATA:POINts, 4-14
- DATA subsystem , 5-15
- data transfer format, 5-42
 - ASCII, 5-42
 - REAL, 5-43
- DBUF , 5-15
- :DELay
 - ARM, 5-8
 - TRIGger[:SEQuence1], 5-29
- Delay key, 3-11
- deviation measurement, 3-9, 4-9
 - how to display, 2-8, 2-9
 - HP-IB command, 5-12
- Device-Dependent Error Bit, 5-36

- Display , 3-2
- display mode, 2-7, 3-15
 - HP-IB command, 5-17
- DISPlay subsystem , 5-17
- Disp Mode key , 3-15

E

- E key , 3-13
- Elec Size key , 3-8
- electrode size
 - how to set, 2-4
- Enter key , 3-13
- :EPERimeter
 - CALCulate:RESistivity, 5-12
- :ERRor?
 - SYSTem, 5-27
- *ESE, 4-17, 5-31
- *ESR?, 4-17, 5-31
- Execution Error Bit, 5-36
- external trigger input, 3-20
- external trigger mode, 2-6, 3-11, 4-12

F

- :FAIL?
 - CALCulate:LIMit, 5-11
- :FEED
 - DATA, 5-16
- :FEED:CONtrol
 - DATA, 5-16
- FETCh?, 4-11, 5-18
- :FORMat
 - CALCulate, 5-10
- FORMat, 4-14
- :FORMat[:DATA], 5-19
- FORMat subsystem, 5-19
- front panel, 3-2
- :FUNction
 - SENSe, 5-23

G

- GET, 4-11
- :GLENgtH
 - CALCulate:RESistivity, 5-13
- group execution trigger, 4-11

H

- handler interface functional test , 9-24
- High Voltage indicator , 3-4
- Hold range, 3-10
- HP-IB address, 3-11
 - how to set, 2-14

I

Idle state, 5-40
*IDN?, 5-31
IEEE 754 floating point format, 5-19, 5-43
:INITiate:CONTInuous, 4-11, 5-20
:INITiate[:IMMediate], 4-11, 5-20
Initiate state, 5-40
INITiate subsystem , 5-20
insulation resistance measurement, 7-2
interlock connector, 3-3
internal trigger mode, 2-6, 3-11, 4-11
interval time
 how to set, 2-10

K

key lock, 2-14, 3-15, 4-8
 HP-IB command, 5-27
Key Lock key, 3-15
:KLOCK
 SYSTEM, 5-27

L

Lcl key, 3-11
:LFrequency
 SYSTEM, 5-27
:LIMit[:AMPLitude]
 SOURce:CURRent, 5-24
:LIMit:BEEPPer:CONDition
 CALCulate, 5-10
:LIMit:BEEPPer[:STATe]
 CALCulate, 5-10
:LIMit:CLEar
 CALCulate, 5-10
:LIMit:FAIL?
 CALCulate, 5-11
Limit key, 3-12
:LIMit:LOWer[:DATA]
 CALCulate, 5-11
:LIMit:LOWer:STATe
 CALCulate, 5-11
:LIMit:STATe
 CALCulate, 5-11
:LIMit:UPPer[:DATA]
 CALCulate, 5-11
:LIMit:UPPer:STATe
 CALCulate, 5-11
LINE frequency, 3-18
 how to set, 1-9, 4-5
 HP-IB command, 5-27
LINE Fuse Holder , 3-29
LINE Input Receptacle , 3-29
LINE switch , 3-3
LINE voltage selector, 3-29
 How to select, 1-9
local mode, 2-14, 3-11

:LOWer
 CALCulate:LIMit, 5-11
*LRN?, 4-10, 5-31

M

manual changes, A-2
manual trigger mode, 2-6, 3-11, 4-11
:MATH
 CALCulate, 5-12
:MATH:EXPRession:CATalog?
 CALCulate, 5-12
:MATH:EXPRession:NAME
 CALCulate, 5-12
:MATH:STATe
 CALCulate, 5-12
MAV (Message Available) Bit, 5-35
Max key , 3-13
Meas Prmtr key , 3-8
Meas Time key , 3-5
measurement parameter, 3-8
 How to select, 1-19
 HP-IB command, 5-10
measurement range, 3-10
 how to select, 1-20, 4-7
 HP-IB command, 5-23
measurement sequence mode
 how to select, 2-10
measurement time mode, 3-5
 how to select, 2-2, 4-6
 HP-IB command, 5-23
Min key , 3-13

N

<NR1> format, 5-42
<NR3> format, 5-42
number of repetitions
 how to set, 2-11
<numeric_value>, 5-3

O

offset-error canceling
 how to set, 2-15
On/Off key , 3-12
*OPC, 5-31
OPEN correction, 3-14
 how to perform, 1-18, 4-7
 HP-IB command, 5-22
Open key , 3-14
Operation Complete Bit, 5-36
OUTPut, 4-6, 5-21
OUTPut subsystem , 5-21
Overall Block Diagram, 3-33
Overall Measurement Theory, 3-32
OVER CURRENT, 3-5
Over Load, 3-10

OVLD, 3-10

P

:PAGE

DISPlay[:WINDow]:TEXT, 5-17

:PATH?

CALCulate, 5-12

performance test record , 9-21

:POINTs

DATA, 5-16

power cord selection , 3-29

:PRESet

SYSTEM, 5-28

Program key , 3-7

Q

Query, 5-4

Query Error Bit, 5-36

questionable status register, 5-38

R

:RANGe

SENSe:CURRent, 5-23

Range Setup key, 3-10

:RANGe[:UPPer]

SENSe:CURRent, 5-23

*RCL, 4-10, 5-31

Rcl key , 3-11

REAL, 5-19, 5-43

real data format, 4-14

recall, 3-11

instrument settings, 2-13

reference value

how to set, 2-8

reset, 3-16

how to, 1-17, 4-5

Reset key, 3-16

:RESistance:CONtact:VERify

SENSe, 5-23

resistance measurement accuracy test , 9-13

resistivity, 7-3

:RESistivity:EARea

CALCulate, 5-12

:RESistivity:EPERimeter

CALCulate, 5-12

:RESistivity:GLENGth

CALCulate, 5-13

resistivity measurement

how to set parameters for, 2-3

resistivity measurement parameters

how to set, 4-8

:RESistivity:STHickness

CALCulate, 5-13

RQS (Request Service) Bit, 5-35

*RST, 4-5, 5-32

S

safety considerations, 8-9

safety symbols, vi

sample program, 4-18

*SAV, 4-10, 5-32

save, 3-12

instrument settings, 2-13

Save key , 3-12

self-test, 3-19

how to perform, 2-17, 4-16

HP-IB command, 5-33

:SENSe:AVERage:COUNT, 4-7

:SENSe:AVERage[:STATe], 4-7

:SENSe:CORREction:COLLect OFFSet, 4-7

:SENSe:CURRent:APERture, 4-6

:SENSe:CURRent:RANGe:AUTO, 4-7

:SENSe:CURRent:RANGe[:UPPer], 4-7

:SENSe:FUNCTion, 4-5

:SENSe:RESistance:CONtact:VERify, 4-8

SENSe subsystem , 5-22

<sensor_function>, 5-23

<sensor_function>, 5-4

Seq Abort key , 3-10

Seq Mode key, 3-6

:SEQuence1

ARM, 5-8

[:SEQuence1]:COUNT

TRIGger, 5-29

[:SEQuence1]:DELay

TRIGger, 5-29

[:SEQuence1][:IMMediate]

TRIGger, 5-29

[:SEQuence1][:LAYer]:DELay

ARM, 5-8

[:SEQuence1][:LAYer]:SOURce

ARM, 5-8

[:SEQuence1]:SOURce

TRIGger, 5-30

[:SEQuence1]:TIMer

TRIGger, 5-30

Sequence operation state, 5-41

serial number, A-1

Service Request Enable Register, 5-34

Service Request (SRQ), 5-34

:SOURce

ARM, 5-8

TRIGger, 5-30

SOURce subsystem , 5-24

:SOURce:VOLTage, 4-5

source voltage. *See* test voltage

source voltage accuracy test , 9-4

Source Voltage key , 3-5

Specifications, 8-2

SPOLL, 4-17

- *SRE, 4-17, 5-32
- standard event status register, 5-36
- :STAT, 5-25
- :STATe
 - CALCulate:LIMit, 5-11
 - DISPlay[:WINDow], 5-17
 - OUTPut, 5-21
 - SENSe:CORRection, 5-22
- status, 5-34
 - how to report, 4-16
- status byte register, 5-35
- :STATus:OPERation:CONDition?, 4-17, 5-25
- :STATus:OPERation:ENABle, 4-17, 5-25
- :STATus:OPERation[:EVENT]?, 4-17, 5-25
- :STATus:PRESet, 4-17, 5-25
- :STATus:QUESTionable:CONDition?, 4-17, 5-25
- :STATus:QUESTionable:ENABle, 4-17, 5-26
- :STATus:QUESTionable[:EVENT]?, 4-17, 5-26
- STATus subsystem, 5-25
- *STB?, 4-17, 5-32
- :STHickness
 - CALCulate:RESistivity, 5-13
- supplemental performance characteristics, 8-8
- surface resistivity, 7-4
- :SYSTem:BEEPer[:IMMediate], 4-8
- :SYSTem:BEEPer:STATe, 4-8
- :SYSTem:KLOCK, 4-8
- :SYSTem:LFRequency, 4-5
- :SYSTem:PRESet, 4-5
- SYST:ERR?, 4-16

T

- talk only mode, 2-14
- test equipment , 9-1
- test voltage, 3-5
 - how to apply, 1-21, 4-6
 - how to set, 1-20, 4-5
- Theory of Operation , 3-32
- thickness
 - how to enter, 2-3
- :TIMer

- TRIGger[:SEQuence1], 5-30
- *TRG, 4-11, 5-32
- TRIG, 5-41
 - COUNT, 5-41
 - DELay, 5-41
 - IMMediate, 5-41
 - SOURce, 5-41
- TRIG event detection state, 5-41
- trigger, 3-10
 - how to, 2-6
 - how to trigger, 4-11
- TRIGger, 5-29
- TRIGGER, 4-11
- trigger delay time, 3-11
 - how to set, 2-2, 4-7
 - HP-IB command, 5-29
- :TRIGger[:SEQuence1]:COUNT, 4-15
- :TRIGger[:SEQuence1][:IMMediate], 4-11
- :TRIGger[:SEQuence1]:SOURce, 4-11, 4-15
- :TRIGger[:SEQuence1]:TIMER, 4-15
- :TRIGger[:SEQuence1]:DELay, 4-7
- TRIGger subsystem , 5-29
- trigger system , 5-39
- Trig key , 3-10
- Trig Mode key, 3-11
- *TST?, 4-16, 5-33

U

- Δ Mode key , 3-9
- Δ Ref key , 3-10
- UNKNOWN terminals , 3-4
- :UPPer
 - CALCulate:LIMit, 5-11

V

- :VERSion?
 - SYSTem, 5-28
- :VOLTage
 - SOURce, 5-24
- volume resistivity, 7-3
- V Output indicator , 3-5
- V Output key , 3-4

W

- *WAI, 5-33

Customer Comment Card

HP 4339A High Resistance Meter Operation Manual

Part No.: 04339-90000

Second Edition (December 1992)

We welcome your evaluation of this manual. Your comments and suggestions will help us improve our publications. Attach additional pages if necessary.

Please circle one number for each statement below as it applies to the manual:

(5 = Strongly agree; 3 = Neutral; 1 = Strongly disagree)

- | | | | | | |
|---|---|---|---|---|---|
| • Is there enough information? | 5 | 4 | 3 | 2 | 1 |
| • Is the information technically accurate? | 5 | 4 | 3 | 2 | 1 |
| • Can you easily find the information you want? | 5 | 4 | 3 | 2 | 1 |
| • Are instructions complete? | 5 | 4 | 3 | 2 | 1 |
| • Are descriptions and instructions easy to understand? | 5 | 4 | 3 | 2 | 1 |
| • Are there enough examples? | 5 | 4 | 3 | 2 | 1 |
| • Are the examples helpful? | 5 | 4 | 3 | 2 | 1 |
| • Are there enough figures? | 5 | 4 | 3 | 2 | 1 |
| • Are the figures helpful? | 5 | 4 | 3 | 2 | 1 |
| • Is the index thorough? | 5 | 4 | 3 | 2 | 1 |
| • Is this manual well organized? | 5 | 4 | 3 | 2 | 1 |

Additional Comments: _____

Please provide:

Name: _____

Title: _____

Company: _____

Address: _____

City: _____ State: _____ Zip Code/Country _____

Remove this card and fold so that the address is on the outside. Tape, and mail.

OR forward to your Hewlett-Packard Sales Representative. (Sales offices, please forward to KID or your Marketing Center.)

Thank you for your assistance.

.....Fold here.....Fold here.....

AFFIX
STAMP
HERE

HEWLETT-PACKARD COMPANY
KID Marketing
T&M US Marketing Center M/S 54L-AL
5301 Stevens Creek Blvd.
Santa Clara, CA 95052
USA

.....Fold here.....Fold here.....

REGIONAL SALES AND SUPPORT OFFICES

For information relating to Sales or Support of Hewlett-Packard products first contact your local Hewlett-Packard office listed in the white pages of your telephone directory. If none is listed locally, contact one of the addresses listed below to obtain the address or phone number of the Hewlett-Packard Sales or Support office nearest you.

ASIA

Hewlett-Packard Asia Ltd.
47/F, 26 Harbour Road,
Wanchai, HONG KONG
G.P.O. Box 863, Hong Kong
Tel: (852)5-8330833
Telex: 76793 HPA HX
Cable HPASIAL TD

AUSTRALASIA

Hewlett-Packard Australia Ltd.
31-41 Joseph Street
BLACKBURN, Victoria 3130
Australia
Tel: (61)895-2895
Telex: 31-024
Cable: HEWPARD Melbourne

CANADA

Hewlett-Packard (Canada) Ltd.
6877 Goreway Drive
MISSISSAUGA, Ontario L4V 1M8
Tel: (416)678-9430
Telex: 069-8644

JAPAN

Yokogawa-Hewlett-Packard Ltd.
29-21 Takaido-Higashi, 3 Chome
Suginami-ku TOKYO 168
Tel: 03(331)6111
Telex: 232-2024 YHPTOK

MEDITERRANEAN AND MIDDLE EAST

Hewlett-Packard S.A.
Mediterranean and Middle East
Operations
Atrina Centre
32 Kifissias Avenue
Paradissos-Amarousion, ATHENS
Greece
Tel: (30)682 88 11
Telex: 21-6588 HPAT GR
Cable: HEWPACKSA Athens

BENELUX & SCANDINAVIA

Hewlett-Packard S.A.
Uilcnstede 475
P.O. Box 999
NL-1183 AG AMSTELVEEN
The Netherlands
Tel: (31)20/43 77 71
Telex: 18 919 hpner nl

SOUTH & EAST EUROPE, AFRICA

Hewlett-Packard S.A.
7 rue du Bois-du-Lan
CH-1217 MEYRIN 2, Geneva
Switzerland
Tel: (41)22/83 12 12
Telex: 27835 hmea
Cable: HEWPACKSA Geneva

FRANCE

Hewlett-Packard France
Parc d'activites du Bois Briard
2, avenue du Lac
91040 EVRY Cedex
Tel: 1 6/077 83 83
Telex: 6923 15F

GERMAN FEDERAL REPUBLIC

Hewlett-Packard GmbH
Hewlett-Packard-Strasse
Postfach 1641
D-6380 BAD HOMBURG
West Germany
Tel: 06172/400-0
Telex: 410 844 hpbhg

ITALY

Hewlett-Packard Italiana S.p.A.
Via G. Di Vittorio 9
I-20063 CERNUSCO SUL
NAVIGLIO
(Milano)
Tel: 02/92 36-91
Telex: 334632

UNITED KINGDOM

Hewlett-Packard Ltd.
King Street Lane
Winnersh, WOKINGHAM
Berkshire RG11 5AR
Tel: 734/78/ 47 74
Telex: 847178

EASTERN USA

Hewlett-Packard Co.
4 Choke Cherry Road
ROCKVILLE, MD 20850
TEL: (301)670-4300

MIDWESTERN USA

Hewlett-Packard Co.
5201 Tollview Drive
ROLLING MEADOWS, IL 6008
Tel: (312)255-9800

SOUTHERN USA

Hewlett-Packard Co.
2000 South Park Place
P.O. Box 105005
ATLANTA, GA 30348
Tel: (404)955-1500

WESTERN USA

Hewlett-Packard Co.
5161 Lankershim Blvd.
P.O. Box 3919
NO. HOLLYWOOD, CA 91609
Tel: (818)506-3700

OTHER INTERNATIONAL AREAS

Hewlett-Packard Co.
Intercontinental Headquarters
3495 Deer Creek Road
PALO ALTO, CA 94304
Tel: (415)857-1501
Telex: 034-8300
Cable: HEWPACK

